

32MD301B/32MD311B 26MD301B/26MD311B 19MD301B/19MD311B LCD TV/DVD



Thank you for choosing
Magnavox.

Need help fast?

Read your Owner's Manual first for quick tips that make using your Magnavox product more enjoyable. If you have read your instructions and still need assistance, you may access our online help at www.magnavox.com/support or call **1-866-341-3738** while with your product (and Model / Serial number)



Magnavox vous remercie de
votre confiance.

Besoin d'une aide rapide?

Manuel du Propriétaire regorgent d'astuces destinées à simplifier l'utilisation de votre produit Magnavox. Toutefois, si vous ne parvenez pas à résoudre votre problème, vous pouvez accéder à notre aide en ligne à l'adresse www.magnavox.com/support ou formez le **1-866-341-3738**. Veillez à avoir votre produit à portée de main (et model / serial nombre)



Gracias por escoger Magnavox.

Necesita ayuda inmediata?

Lea primero el Manual del Propietario, en donde encontrará consejos que le ayudarán a disfrutar plenamente de su producto Magnavox. Si después de leerlo aún necesita ayuda, consulte nuestro servicio de asistencia en línea en www.magnavox.com/support o llame al teléfono **1-866-341-3738** y tenga a mano el producto (y número de model / serial)

English

Français

Español



MODEL NUMBER

SERIAL NUMBER



Return your Product Registration Card or register online at www.magnavox.com/support today to get the very most from your purchase.

Registering your model with MAGNAVOX makes you eligible for all of the valuable benefits listed below, so don't miss out. Complete and return your Product Registration Card at once, or register online at www.magnavox.com/support to ensure:

*Product Safety Notification



By registering your product, you'll receive notification - directly from the manufacturer - in the rare case of a product recall or safety defect.

*Additional Benefits

Registering your product guarantees that you'll receive all of the privileges to which you're entitled, including special money-saving offers.

Know these
safety symbols



-  This "bolt of lightning" indicates uninsulated material within your unit may cause an electrical shock. For the safety of everyone in your household, please do not remove product covering.
-  The "exclamation point" calls attention to features for which you should read the enclosed literature closely to prevent operating and maintenance problems.

WARNING: To reduce the risk of fire or electric shock, this apparatus should not be exposed to rain or moisture and objects filled with liquids, such as vases, should not be placed on this apparatus.

CAUTION: To prevent electric shock, match wide blade of plug to wide slot, fully insert.

ATTENTION: Pour éviter les choc électriques, introduire la lame la plus large de la fiche dans la borne correspondante de la prise et pousser jusqu'au fond.

MAGNAVOX

Visit our World Wide Web Site at www.magnavox.com/support

Wall Mount Bracket Kit

Recommended Wall Mount Bracket Kit:

Brand: SANUS

Model #: 32MD301B/32MD311B San25b
26MD301B/26MD311B SAN213b

<for 32 inches, 26 inches only>



Do NOT use screws packed with Wall Mount Bracket Kit.

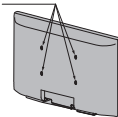

19MD301B/19MD311B San10B

Recommended Screw dimension when purchased:

32MD301B/32MD311B M4×0.787" (20mm)
+ Washer 0.078" (T2mm)

26MD301B/26MD311B M4×0.629" (16mm)

19MD301B/19MD311B M4×0.472" (12mm)

- The recommended Wall Mount Bracket Kit (sold separately) allows the mounting of the TV on the wall.
- For detailed information on installing the wall mount, refer to the Wall Mount Instruction Book.
- Funai is not responsible for any damage to the product or injury to yourself or others if you elect to install the TV Wall Mount Bracket or mount the TV onto the Bracket on your own.
- Wall Mount Bracket Kit is sold separately and is not supplied.
- The Wall Mount Bracket must be installed by experts.

Funai not liable for these types of accidents or injury noted below.

- Install the Wall Mount Bracket on a sturdy vertical wall.
- If installed onto a ceiling or slanted wall, the TV and Wall Mount Bracket may fall which could result in a severe injury.
- Do not use screws that are longer or shorter than their specified length. If screws too long are used this may cause mechanical or electrical damage inside the TV set. If screws too short are used this may cause the TV set to fall.
- Do not fasten the screws by excessive force; this may damage the product or cause the product to fall, leading to an injury.
- For safety reasons use 2 people to mount the TV onto a Wall Mounting Bracket.
- Do not mount the TV onto the Wall Mounting Bracket while your TV is plugged in or turned on. It may result in an electrical shock injury.

When installing the unit on the wall, allow this much space.

Top:	11.8 inches (30cm)
Left and right side:	5.9 inches (15cm)
Bottom:	3.9 inches (10cm)

IMPORTANT SAFETY INSTRUCTIONS

Read before operating equipment

1. Read these instructions.
2. Keep these instructions.
3. Heed all warnings.
4. Follow all instructions.
5. Do not use this apparatus near water.
6. Clean only with a dry cloth.
7. Do not block any of the ventilation openings.
Install in accordance with the manufacturer's instructions.
8. Do not install near any heat sources such as radiators, heat registers, stoves, or other apparatus (including amplifiers) that produce heat.
9. Do not defeat the safety purpose of the polarized or grounding-type plug. A polarized plug has two blades with one wider than the other. A grounding type plug has two blades and third grounding prong. The wide blade or third prong are provided for your safety. When the provided plug does not fit into your outlet, consult an electrician for replacement of the obsolete outlet.
10. Protect the power cord from being walked on or pinched particularly at plugs, convenience receptacles, and the point where they exit from the apparatus.
11. Only use attachments/accessories specified by the manufacturer.
12.  Use only with a cart, stand, tripod, bracket, or table specified by the manufacturer; or sold with the apparatus. When a cart is used, use caution when moving the cart/apparatus combination to avoid injury from tip-over.
13. Unplug this apparatus during lightning storms or when unused for long periods of time.
14. Refer all servicing to qualified service personnel. Servicing is required when the apparatus has been damaged in any way, such as power-supply cord or plug is damaged, liquid has been spilled or objects have fallen into apparatus, the apparatus has been exposed to rain or moisture, does not operate normally, or has been dropped.
15. **Damage Requiring Service** - The appliance should be serviced by qualified service personnel when:
 - A. The power supply cord or the plug has been damaged;
 - B. Objects have fallen, or liquid has been spilled into the appliance;
 - C. The appliance has been exposed to rain
 - D. The appliance does not appear to operate normally or exhibits a marked change in performance;
 - E. The appliance has been dropped, or the enclosure damaged.
16. **Tilt/Stability** - All televisions must comply with recommended international global safety standards for tilt and stability properties of its cabinet design.
 - Do not compromise these design standards by applying excessive pull force to the front, or top, of the cabinet which could ultimately overturn the product.
 - Also, do not endanger yourself, or children, by placing electronic equipment/toys on the top of the cabinet. Such items could unsuspectingly fall from the top of the set and cause product damage and/or personal injury.
17. **Wall or Ceiling Mounting** - The appliance should be mounted to a wall or ceiling only as recommended by the manufacturer.
18. **Power Lines** - An outdoor antenna should be located away from power lines.
19. **Outdoor Antenna Grounding** - If an outside antenna is connected to the receiver, be sure the antenna system is grounded so as to provide some protection against voltage surges and built up static charges.
Section 810 of the National Electric Code, ANSI/NFPA No. 70-1984, provides information with respect to proper grounding of the mast and supporting structure, grounding of the lead-in wire to an antenna discharge unit, size of grounding connectors, location of antenna-discharge unit, connection to grounding electrodes, and requirements for the grounding electrode. See Figure below.
20. **Object and Liquid Entry** - Care should be taken so that objects do not fall and liquids are not spilled into the enclosure through openings.
21. **Battery Usage CAUTION** - To prevent battery leakage that may result in bodily injury, property damage, or damage to the unit:
 - Install all batteries correctly, with + and - aligned as marked on the unit.
 - Do not mix batteries (old and new or carbon and alkaline, etc.).
 - Remove batteries when the unit is not used for a long time.

Note to the CATV system installer : This reminder is provided to call the CATV system installer's attention to Article 820-40 of the NEC that provides guidelines for proper grounding and, in particular, specifies that the cable ground shall be connected to the grounding system of the building, as close to the point of cable entry as practical.

Example of Antenna Grounding as per NEC - National Electric Code

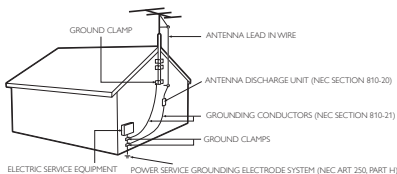

FCC WARNING

This apparatus may generate or use radio frequency energy. Changes or modifications to this apparatus may cause harmful interference unless the modifications are expressly approved in the manual. The user could lose the authority to operate this apparatus if an unauthorized change or modification is made.

RADIO-TV INTERFERENCE

This apparatus has been tested and found to comply with the limits for a Class B digital device, pursuant to Part 15 of the FCC Rules. These limits are designed to provide reasonable protection against harmful interference in a residential installation. This apparatus generates, uses, and can radiate radio frequency energy and, if not installed and used in accordance with the instructions, may cause harmful interference to radio communications. However, there is no guarantee that interference will not occur in a particular installation. If this apparatus does cause harmful interference to radio or television reception, which can be determined by turning the apparatus off and on, the user is encouraged to try to correct the interference by one or more of the following measures:

- 1) Reorient or relocate the receiving antenna.
- 2) Increase the separation between the apparatus and receiver.
- 3) Connect the apparatus into an outlet on a circuit different from that to which the receiver is connected.
- 4) Consult the dealer or an experienced radio/TV technician for help.

DECLARATION OF CONFORMITY

Trade Name: MAGNAVOX

Model: 32MD301B/32MD311B

26MD301B/26MD311B

19MD301B/19MD311B

Responsible Party: FUNAI CORPORATION, Inc.

Address: 19900 Van Ness Avenue, Torrance, CA 90501 U.S.A.

Telephone Number: 1-866-341-3738

This Class B digital apparatus complies with Canadian ICES-003. Standard Television Receiving Apparatus, Canada BETS-7/NTMR-7

CAUTION: Danger of explosion if battery is incorrectly replaced. Replace only with the same or equivalent type.
WARNING: Batteries (battery pack or battery installed) shall not be exposed to excessive heat such as sunshine, fire or the like.

Disconnect the mains plug to shut off when find trouble or not in use. The mains plug shall remain readily operable.

This apparatus should not be placed in a built-in installation such as a bookcase or rack unless proper ventilation is provided. Make sure to leave a space of 4 inches (10cm) or more around this apparatus.

WARNING: To prevent injury, this apparatus must be securely attached to the wall in accordance with the instructions.

Do not place the unit on the furniture that is capable of being tilted by a child and an adult leaning, pulling, standing or climbing on it. A falling unit can cause serious injury or even death.

LASER SAFETY

This apparatus is classified as a CLASS 1 LASER PRODUCT. This apparatus employs a laser. Only a qualified service person should remove the cover or attempt to service this apparatus, due to possible eye injury.

CAUTION: Use of controls or adjustments or performance of procedures other than those specified herein may result in hazardous radiation exposure.

CLASS 1 LASER PRODUCT
CLASSE 1 PRODUIT LASER
PRODUCT CON LASER CLASSE 1

IMPORTANT COPYRIGHT INFORMATION

Unauthorized copying, broadcasting, public performance and lending of discs are prohibited. This item incorporates copy protection technology that is protected by U.S. patents and other intellectual property rights of Rovi Corporation. Reverse engineering and disassembly are prohibited.

 Like all LCD products, this set contains a lamp with Mercury, please dispose of according to all Local, State and Federal laws. For the disposal or recycling information, contact:
www.mygreenelectronics.com or www.eiae.org

NOTE ABOUT RECYCLING

- This unit's packaging materials are recyclable and can be reused. Please dispose of any materials in accordance with your local recycling regulations.
- Batteries should never be thrown away or incinerated but disposed of in accordance with your local regulations concerning chemical wastes.

**WHEN CARRYING THIS UNIT**

- At least 2 people are required when carrying this unit.
- Make sure to hold the upper and bottom frames of the unit firmly as illustrated.

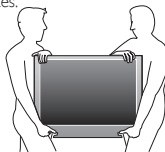
**TO AVOID THE HAZARDS OF ELECTRICAL SHOCK AND FIRE**

- Do not handle the AC power cord with wet hands.
- Do not pull on the AC power cord when disconnecting it from an AC outlet. Grasp it by the plug.
- Do not put your fingers or objects into the unit.

LOCATION AND HANDLING

- Do not install the unit in direct sunlight or in a place subject to dust or strong vibration.
- Avoid a place with drastic temperature changes.
- Install the unit in a horizontal and stable position. Do not place anything directly on top or bottom of the unit. Depending on your external devices, noise or disturbance of the picture and/or sound may be generated if the unit is placed too close to them. In this case, please ensure enough space between the external devices and the unit.
- Depending on the environment, the temperature of this unit may increase slightly. This is not a malfunction.
- Be sure to unplug the AC power cord from the AC outlet before moving or carrying the unit.

DEW CONDENSATION WARNING

- Dew condensation may form inside the unit in the following conditions. If so, do not use this unit at least for a few hours until its inside gets dry.
 - The unit is moved from a cold place to a warm place.
 - Under conditions of high humidity.
 - After heating a cold room.

CHILD SAFETY:

It Makes A Difference How and Where
You Use Your Flat Panel Display

Congratulations on your purchase! As you enjoy your new product, please keep these safety tips in mind:



THE ISSUE

- The home theater entertainment experience is a growing trend and larger flat panel displays are popular purchases. However, flat panel displays are not always supported on the proper stands or installed according to the manufacturer's recommendations.
- Flat panel displays that are inappropriately situated on dressers, bookcases, shelves, desks, speakers, chests or carts may fall over and cause injury.

THIS MANUFACTURER CARES!

- The consumer electronics industry is committed to making home entertainment enjoyable and safe.

TUNE INTO SAFETY

- One size does NOT fit all. Follow the manufacturer's recommendations for the safe installation and use of your flat panel display.
- Carefully read and understand all enclosed instructions for proper use of this product.
- Don't allow children to climb on or play with furniture and television sets.
- Don't place flat panel displays on furniture that can easily be used as steps, such as a chest of drawers.
- Remember that children can become excited while watching a program, especially on a "larger than life" flat panel display. Care should be taken to place or install the display where it cannot be pushed, pulled over, or knocked down.
- Care should be taken to route all cords and cables connected to the flat panel display so that they cannot be pulled or grabbed by curious children.

WALL MOUNTING: IF YOU DECIDE TO WALL MOUNT YOUR FLAT PANEL DISPLAY, ALWAYS:

- Use a mount that has been recommended by the display manufacturer and/or listed by an independent laboratory (such as UL, CSA, ETL).
- Follow all instructions supplied by the display and wall mount manufacturers.
- If you have any doubts about your ability to safely install your flat panel display, contact your retailer about professional installation.
- Make sure that the wall where you are mounting the display is appropriate. Some wall mounts are not designed to be mounted to walls with steel studs or old cinder block construction. If you are unsure, contact a professional installer.
- A minimum of two people are required for installation. Flat panel displays can be heavy.



INTRODUCTION

Contents

Important Safety Instructions	3
Child Safety	5

INTRODUCTION

Trademark Information	6
Features	7
Supplied Accessories	8
Symbols Used in this Manual	8
Mounting the Unit on Your Furniture	8
Tilt Stand <19MD301B/19MD311B only>	8
Attaching the Base	9
Installing the Batteries	9
Control Panel	10
Terminals	10
Remote Control Function	12

PREPARATION

Antenna Connection	13
Connection to Cable Receiver or Satellite Box	14
Plug In the AC Power Cord	14
Initial Setup	15

WATCHING TV

Sleep Timer	16
Switching Each Input Mode	16
Freeze Mode	16
Channel Selection	16
TV Screen Display Mode	17
Sound Functions	17
TV Screen Information	18

USING FUNCTIONS

Picture	20
Sound	20
Channel	21
Features	22
Language	27
DVD	27
Language Code List	29

OPERATING DVD

Playable Media	30
Unplayable Media	30
Playback	31
Disc Menu	31
Resume Playback	31
Paused and Step-by-step Playback	31
Fast Forward/Fast Reverse	31
Slow Forward/Slow Reverse	32
Zoom	32
Search Functions	32
Repeat Playback	33
Repeat A-B Playback	33
Random Playback	33
Programmed Playback	33
On-screen Display	34
Special Settings	34

CONNECTING DEVICES

External Device Connection	36
Cable Management	
<32MD301B/32MD311B/26MD301B/26MD311B only>	39

USEFUL TIPS

Troubleshooting Guide	40
FAQ	42

INFORMATION

Glossary	43
Maintenance	43
General Specifications	44
Other Specifications	44
Limited Warranty	47

Trademark Information



- HDMI, the HDMI Logo, and High-Definition Multimedia Interface are trademarks or registered trademarks of HDMI Licensing LLC in the United States and other countries.



- Manufactured under license from Dolby Laboratories. Dolby and the double-D symbol are trademarks of Dolby Laboratories.



- ENERGY STAR® is a joint program of the U.S. Environmental Protection Agency and the U.S. Department of Energy helping us all save money and protect the environment through energy efficient products and practices.

Consumer Notice:

This TV has been set to maximize energy efficiency while delivering the best possible picture using the factory installed home mode settings.

Changing or enabling other features in this TV (e.g. brightened backlighting) will possibly increase energy consumption beyond the original ENERGY STAR® qualified limits.

- DVD** is a trademark of DVD Format/Logo Licensing Corporation.
- The American Academy of Pediatrics discourages television viewing for children younger than two years of age.

© 2011 Funai Electric Co., Ltd.

All rights reserved. No part of this manual may be reproduced, copied, transmitted, disseminated, transcribed, downloaded or stored in any storage medium, in any form or for any purpose without the express prior written consent of Funai. Furthermore, any unauthorized commercial distribution of this manual or any revision hereto is strictly prohibited.

Information in this document is subject to change without notice. Funai reserves the right to change the content herein without the obligation to notify any person or organization of such changes.

FUNAI with the  design is a registered trademark of Funai Electric Co., Ltd. and may not be used in any way without the express written consent of Funai. All other trademarks used herein remain the exclusive property of their respective owners. Nothing contained in this manual should be construed as granting, by implication or otherwise, any license or right to use any of the trademarks displayed herein. Misuse of any trademarks or any other content in this manual is strictly prohibited. Funai shall aggressively enforce its intellectual property rights to the fullest extent of the law.

MAGNAVOX is a registered trademark of Philips Electronics North America Corporation and is used by Funai Electric Co. Ltd. and Funai Corporation, Inc. under license from Philips Electronics North America.

Features

TV

- **DTV/TV/CATV**
You can use your remote control to select channels which are broadcast in digital format and conventional analog format. Also, cable subscribers can access their cable TV channels.
 - **Information Display (ATSC only)**
You can display the title, contents and other information of the current DTV program on the TV screen.
 - **Autoprogram**
This unit automatically scans and memorizes channels available in your area, eliminating difficult setup procedures.
 - **Child Lock**
This feature allows you to block children's access to inappropriate programs.
 - **Closed Caption Decoder**
Built-in closed caption decoder displays text for closed caption supported programs.
 - **MTS/SAPTuner**
Audio can be selected from the remote control.
 - **Auto Standby**
If there is no input signal and no operation for 15 minutes, the unit will go into standby mode automatically.
 - **Sleep Timer**
You can set the unit to go into standby mode after a specific amount of time.
 - **Choices for On-screen Language**
Select your on-screen language:
English, Spanish or French.
 - **Stereo Sound Function**
 - **PLL Frequency Synthesized Tuning**
Provides free and easy channel selection and lets you tune directly to any channel using the number and decimal point "•" buttons on the remote control.
 - **Various Adjustment for Picture and Sound**
Customizes image quality suitable for your room and sets your sound preference.
 - **fun-Link via HDMI Link (HDMI Cable not Included)**
fun-Link allows your other HDMI link devices to be controlled by the HDMI cable connected to your TV.
 - **HDMI Input**
When using HDMI1 Input, you can enjoy this unit as a PC monitor if your PC has a DVI output terminal.
 - **HDMI-DVI Input**
 - **Component Video Input**
 - **S-Video Input**
 - **AV Input**
 - **Digital Audio Output**
- <32MD301B/32MD311B/26MD301B/26MD311B only>
- **Analog Audio output**
- <19MD301B/19MD311B only>
- **PC Input**
 - **Headphone Audio Output**

DVD

- **Dolby Digital Sound**
Enjoy Dolby Digital multi-channel surround sound when you connect the unit to your Dolby Digital decoder.
- **Still/Fast/Slow/Step Playback**
Various playback modes are available including still pictures, fast forward/reverse, slow motion and step frames.
- **DVD Menus in a Desired Language**
You can display DVD menus in a desired language, if available on a DVD-video.
- **Auto standby**
If there is no operation for 20 minutes, the unit will go into standby mode automatically.
- **Parental Lock**
Block the viewing of a DVD-video unsuitable for children.
- **Resume Playback**
Lets you resume playback from the point at which playback was stopped.
- **Bit Rate Indication**
- **DRC (dynamic range control)**
You can control the range of sound volume.

Accessing from **MODE** button

During playback

- **Subtitles in a Desired Language**
You can select a desired language for displaying subtitle, if that language is available on a DVD-video.
- **Selecting a Camera Angle**
You can select the desired camera angle, if a DVD contains sequences recorded from different angles.
- **Zoom**
Allows you to enlarge the size of picture image.
- **Black Level Adjustment**
- **Virtual Surround**
- **Search**
chapter search/title search/track search/time search
- **Marker**
The part on the disc designated by user can be called back.
- **Repeat**
chapter/title/track/all/A-B

Accessing from **MODE** button

In stop mode

- **Program Playback for audio CD**
You can program the order of tracks to play them back in designated order.
- **Random Playback for audio CD**
This unit can shuffle the order of tracks to play them back in randomly.

Accessing from **AUDIO** button

During playback

- **Choices for Audio Language and Stereo Sound Function**
Select your desired languages or stereo sound function when different options are available on your disc.

Supplied Accessories

Owner's Manual



Quick Start Guide



Registration card



Remote Control (NF801UD)

Batteries (AAA, 1.5V x 2)



TV base and screws



Screws packed with this unit:

Model	Quantity	Size
32MD301B	4	M4 x 20
32MD311B	4	M4 x 20
26MD301B	4	M4 x 20
26MD311B	4	M4 x 20
19MD301B	3	M4 x 12
19MD311B	3	M4 x 12

Note

- If you lose the screws, please purchase the above-mentioned Phillips head screws at your local store.
- If you need to replace these accessories, please refer to the part No. with the illustrations and call our toll free customer support line found on the cover of this manual.

When using a universal remote control to operate this unit.

- Make sure the component code on your universal remote control is set to our brand. Refer to the manual accompanying your remote control for more details.
- We do not guarantee 100% interoperability with all universal remote controls.

Mounting the Unit on Your Furniture

Screw this unit on your furniture tightly using wood screws (not supplied) in the 2 holes at the back of the base as shown.

- Recommended screw dimension : 0.201 x 0.788 inches (5.1 x 20 mm)

rear of this unit

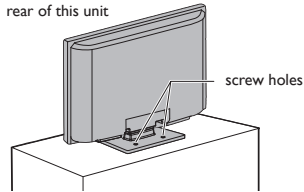

Note

- When you remove this unit make sure to unscrew the wood screws from your Wood Stand, Furniture and other wood item.

Tilt Stand

<19MD301B/19MD311B only>

You can adjust the stand to change the angle of the unit (-2.5° to 10°).

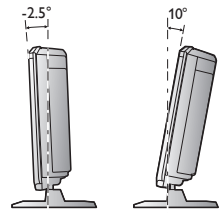

Symbols Used in this Manual

The following is the description for the symbols used in this manual. Description refers to:

TV FUNCTIONS

ATSC : Digital TV operation

NTSC : Analog/Cable TV operation

- If neither symbol appears, the operation is applicable to both.

DVD FUNCTIONS

DVD : Playback of DVD-video

CD : Playback of audio CD

- If neither symbol appears under the function heading, operation is applicable to both.

Attaching the Base

You must attach the base to the unit to have it as a table top unit. Be sure the front and rear of the base match the proper direction. At least 2 people are required for these steps.

1 Spread a thick and soft cloth over a table as shown at step 2. Place the main unit face down onto it. Make sure not to damage the screen.

2 Insert 2 hooks under the bottom of the main unit into base holes. (shown by arrow ①), then move the base in the direction as shown by arrow ② until it stops and the screw holes are aligned.

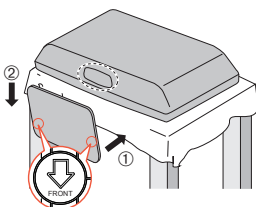

Make sure not to put the AC power cord between the base and the unit.

3 Drive Phillips head screws into the threaded holes at the bottom of the base until they are tight.

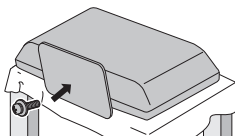

To remove the base from this unit

- Unscrew the Phillips head screws in step 3. After the screws are removed, move the base in the opposite direction as shown by arrow in step 2, then pull the base up toward the rear of the unit. Be careful not to drop the base when you remove it.

Note

- When attaching the base, ensure that all screws are tightly fastened. If the base is not properly attached, it could cause the unit to fall, resulting in injuries as well as damage to the unit.
- Make sure to use a table which can support the weight of this unit and is larger than this unit.
- Make sure the table is in a stable location.
- When attaching the base, ensure that FRONT ↑ written on the base is upward. If it's not upward, the 2 hooks don't fit in the base.

Installing the Batteries

Install the batteries (AAA, 1.5V x 2) matching the polarity indicated inside battery compartment of the remote control.



Battery Precautions:

- Be sure to follow the correct polarity as indicated in the battery compartment. Reversed batteries may cause damage to the device.
- Do not mix different types of batteries together (e.g. Alkaline and Carbon-Zinc, or rechargeable batteries like ni-cad, ni-mh, etc) or old batteries with fresh ones.
- If the device is not to be used for a long period of time, remove the batteries to prevent damage or injury from possible battery leakage.
- Do not try to recharge batteries; they can overheat and rupture.

Control Panel

MD301B series

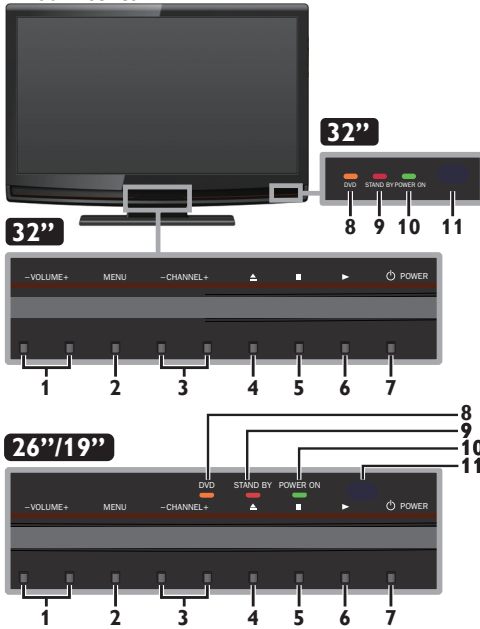

- 1 **VOLUME +/-** → p.17
Press to adjust the volume or move right (+)/left (-) through the main menu items.
- 2 **MENU** → p.19
- 3 **CHANNEL +/-** → p.16
Press to select channels or move up (+)/down (-) through the main menu items.
- 4 **▲ (eject)** → p.31
- 5 **■ (stop)** → p.31
- 6 **▶ (play)** → p.31
- 7 **⏻ POWER** → p.15
Press to turn the unit on and go into standby mode. To completely turn off the unit, you must unplug the AC power cord.
- 8 **DVD indicator**
Lights up orange when a disc is inserted.
- 9 **STAND BY indicator**
Lights up red when the unit goes into standby mode.
- 10 **POWER ON indicator**
Lights up green when power is on.
- 11 **Infrared sensor window**
Receives infrared rays transmitted from the remote control.

MD311B series

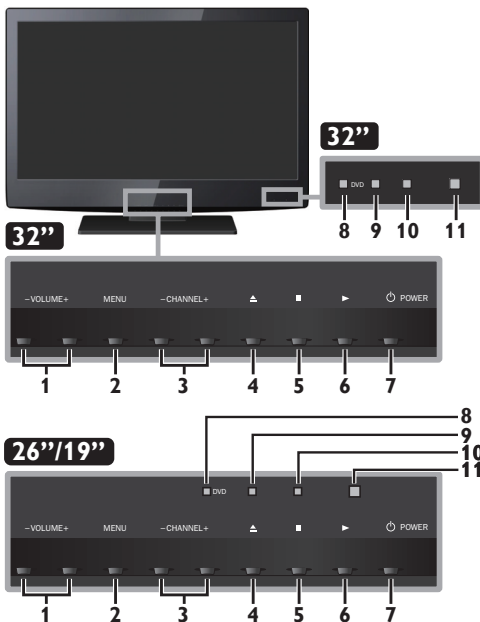

Terminals

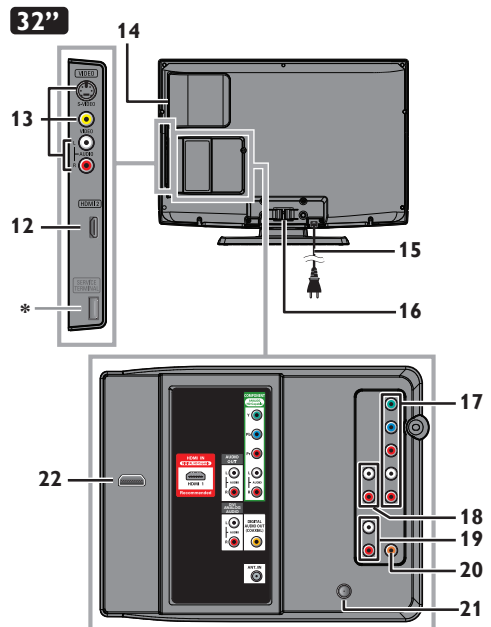

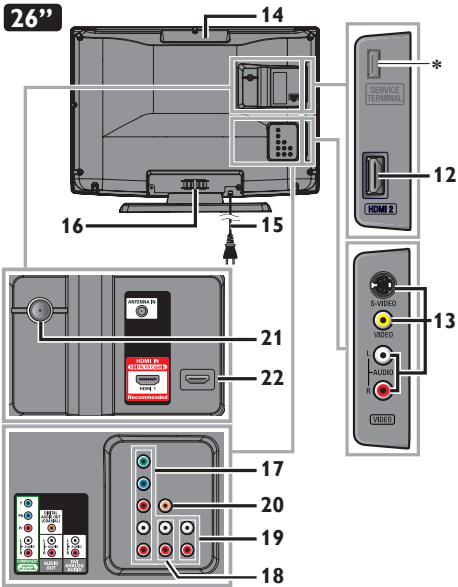

<32MD301B/32MD311B/26MD301B/26MD311B>

Side Panel

- 12 HDMI 2 Input jack ➡ p.14, 36
 13 S-Video/Composite Video/Audio (L/R) Input jacks for VIDEO ➡ p.37, 38

Rear Panel

- 14 Disc loading slot ➡ p.31
 15 AC power cord ➡ p.14
 16 Cable management ➡ p.39
 17 Component Video and Audio (L/R) Input jacks ➡ p.14, 37
 18 Analog Audio (L/R) Output jacks ➡ p.39
 19 Analog Audio (L/R) Input jacks for HDMI 1 ➡ p.36, 39

Audio cable connection from a DVI device.

When you connect your PC that has a DVI terminal, use a stereo mini plug conversion cable as well. (For HDMI 1 Input jack only)

- 20 Digital Audio Output jack ➡ p.38
 21 Antenna Input jack ➡ p.13
 22 HDMI 1 Input jack ➡ p.14, 36, 39
 HDMI connection for HDMI or DVI device.
 When you connect your PC that has a DVI terminal, you can enjoy this unit as a PC monitor.

<19MD301B/19MD311B>

Side Panel

- 12 HDMI 2 Input jack ➡ p.14, 36
 13 S-Video/Composite Video/Audio (L/R) Input jacks for VIDEO ➡ p.37, 38
 14 Headphone Audio Output jack
 Headphone connection for personal listening.

Rear Panel

- 15 Antenna Input jack ➡ p.13
 16 Disc loading slot ➡ p.31
 17 AC power cord ➡ p.14
 18 PC (VGA) Input jack ➡ p.39
 19 HDMI 1 Input jack ➡ p.14, 36
 20 Component Video and Audio (L/R) Input jacks ➡ p.14, 37
 21 Digital Audio Output jack ➡ p.38
 22 Analog Audio (L/R) Input jack for PC connection ➡ p.39
 Mini-plug audio cable connection from PC.
 23 Analog Audio (L/R) Input jacks for HDMI 1 ➡ p.36

Audio cable connection from a DVI device. (For HDMI 1 Input jack only)

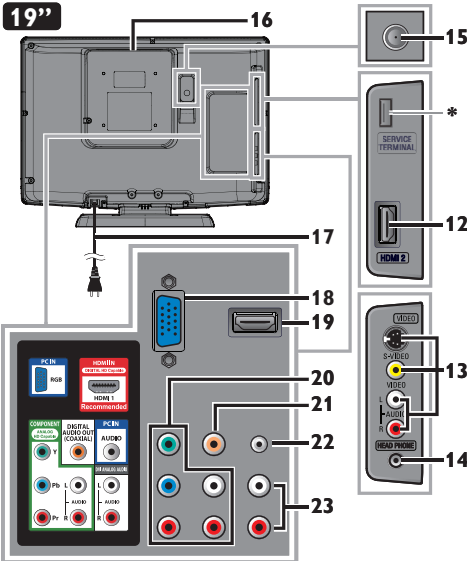

Note for service terminal

* service terminal (service use only)

- Use this terminal only when a software update is necessary.
- User should not connect any devices to the service terminal such as digital camera, keyboard, mouse, etc. (because these will not work).
- The software update is, in most cases, handled by an authorized service person or in some circumstances the user may be asked to do the software update themselves.

Remote Control Function

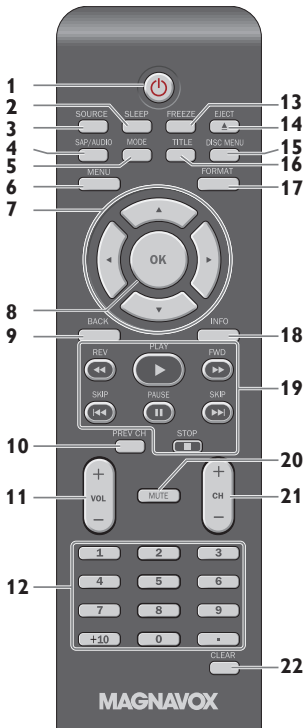

- 1** (power) ➡ p.15
Press to turn the unit on and go into standby mode. To completely turn off the unit, you must unplug the AC power cord.
- 2** SLEEP ➡ p.16
- 3** SOURCE ➡ p.16
- 4** SAP/AUDIO ➡ p.17
- ATSC**
- Press to select the audio language.
- NTSC**
- Press to select the audio mode.
- DVD** **CD**
- Press to select the audio language (DVD), or sound mode (CD).
- 5** MODE ➡ p.7
- Press to arrange the playing order or playback randomly (CD).
 - Press to set the black level (DVD) and the virtual surround on or off.
 - Press to change the camera angle to see the sequence being played back from different angle (DVD).
 - Press to search chapter; title (DVD), track (CD) or time.
 - Press to set the marker.
 - Press to repeat playback chapter; title (DVD), track, disc (CD) repeatedly or between designated point A and B.
 - Press to magnify the part of picture (2x and 4x : DVD).
 - Press to select the subtitles on a disc (DVD).

- 6** MENU ➡ p.19
- 7** (cursor) ➡ p.15
- 8** OK ➡ p.15
- 9** BACK ➡ p.18
- 10** PREV CH ➡ p.16
Press to return to the previously viewed channel.
- 11** VOL +/- ➡ p.17
- 12** Number buttons ➡ p.16
- ATSC** **NTSC**
- Press to select channels.
 - (dot)**
 - Press to shift the subchannel from the main channel.
- DVD** **CD**
- Press to select chapter; title (DVD), or track (CD) directly.
- +10** button
- Press to select 10 or higher number of chapters.
- 13** FREEZE ➡ p.16
- ATSC** **NTSC**
- Press to pause screen image.
- 14** EJECT ➡ p.31
Press to eject the disc.
- 15** DISC MENU ➡ p.31
Press to display the menu on a disc.
- 16** TITLE ➡ p.31
Press to display the title menu (DVD).
- 17** FORMAT ➡ p.17
Press to select aspect ratio available for the TV screen.
- 18** INFO ➡ p.18, 34
- 19** REV /FWD ➡ p.31
Press to begin slow forward or slow reverse playback during the pause mode (DVD) and search backward or forward through a disc.
- PLAY** ➡ p.31
Press to begin the disc playback.
- SKIP** /SKIP ➡ p.32
Press to skip backward or forward chapters, titles (DVD) or tracks (CD) of the disc.
- PAUSE** ➡ p.31
Press to pause the disc playback.
- STOP** ➡ p.31
Press to stop the disc playback.
- 20** MUTE ➡ p.17
- 21** CH +/- ➡ p.16
- 22** CLEAR ➡ p.32, 33
- Press to clear the numbers entered incorrectly.
 - Press to cancel the point A for A-B repeat.
 - Press to remove the track number in program input (CD).

PREPARATION

No supplied cables are used with these connections:

- Please purchase the necessary cables at your local store.

Before you connect:

Be sure your antenna or other device is connected properly before plugging in the AC power cord.

Antenna Connection

Connect the RF coaxial cable on your home outlet to the antenna input jack of this unit.

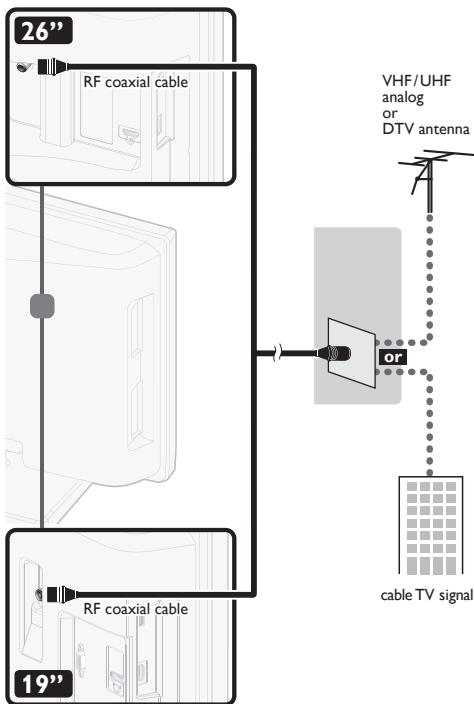
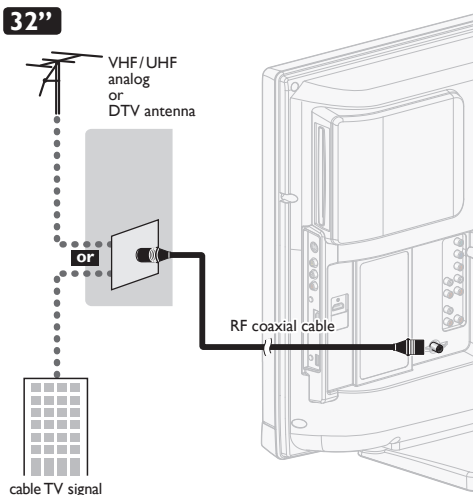

Once connections are completed, turn on the unit and begin initial setup. Channel scanning is necessary for the unit to memorize all available channels in your area. **[Initial Setup]**

▶▶ p.15

Note

- If you have any question about the DTV's antenna, visit www.antennaweb.org for further information.
- Depending on your antenna system, you may need different types of combiners (mixers) or separators (splitters) for HD TV signal. The minimum RF bandpass on these devices is 2,000MHz or 2GHz.
- For your safety and to avoid damage to this unit, please unplug the RF coaxial cable from the antenna input jack before moving the unit.
- If you did use an antenna to receive analog TV, it should also work for DTV reception. Outdoor or attic antennas will be more effective than a set top or inside antenna.
- To switch your reception source easily between antenna and cable, install an antenna selector.
- If you are not receiving a signal from your cable service, contact the Cable provider.

Connection to Cable Receiver or Satellite Box

Use an HDMI or Component Video cables to connect the HDMI or the Component Video Input jacks of the unit to the HDMI or the Component Video output jacks of the cable receiver/satellite box.

If you connect to the unit's Component Video Input jacks, connect Analog Audio cables to the Analog Audio L/R Input jacks for the Component Video connector jacks.

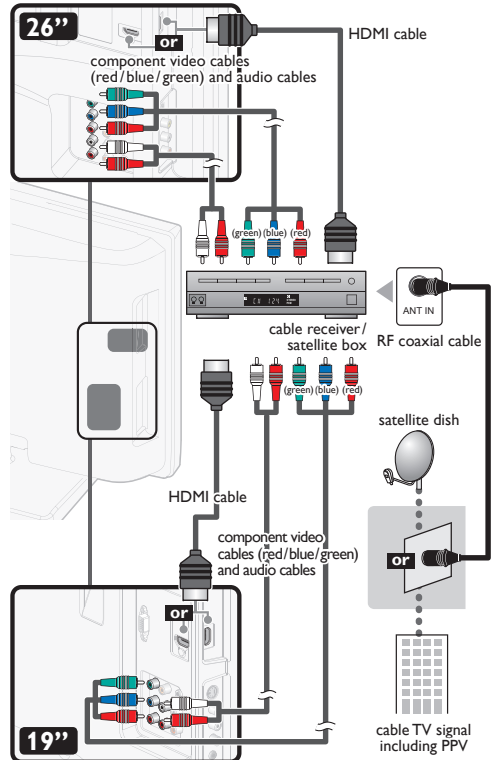
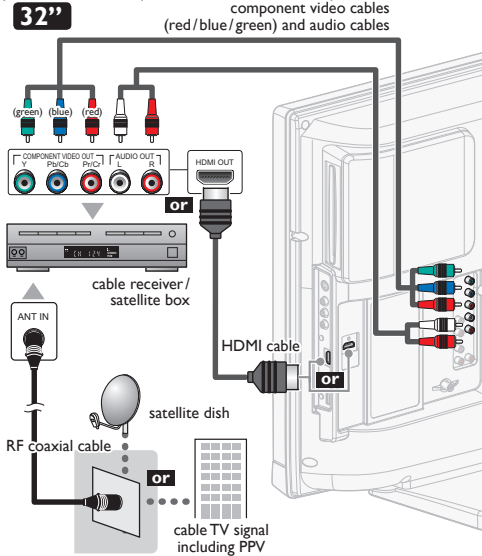

You can also connect this unit to the cable receiver or satellite box other than the HDMI or the Component Video output jacks or Composite Video output jack (▶▶▶ p.37, 38) because they might have different output jacks.

Required cables and connecting methods of the cable receiver/satellite box, or the availability channel for the clear QAM may differ depending on the cable/satellite provider or local TV broadcaster.

For more information, please contact your cable/satellite provider or local TV broadcaster.

Note

- Use an HDMI cable with the HDMI logo (a certified HDMI cable). High Speed HDMI cable is recommended for the better compatibility.

Plug In the AC Power Cord

Make sure that the AC power cord must be plugged to an AC outlet after all the necessary connections are made.

Caution:

- Do not connect the AC power cord to a power supply outside the indicated voltage of this unit (AC 120V). Connecting the AC power cord to a power supply outside of this range may result in fire or electrical shocks.

Note

- Each time you plug in the AC power cord, no operations will be performed for a few seconds. This is not a malfunction.

*These operations are accessible by remote control.
Some may also be accessible by controls on the main unit.*

Initial Setup

This section will guide you through the unit's initial setting which includes selecting a language for your on-screen menu and autoprogram, which automatically scans and memorizes viewable channels.

Before you begin:

Make sure the unit is connected to antenna or cable.

- After making all the necessary connections, press **⏻** to turn on the unit.
 - It may take a few moments to turn on the unit for the first time.
 - [Initial Setup]** menu appears automatically after the unit is turned on.
- Use **▲/▼** to select the on-screen language from the choices (English/Español/Français) on the right side of the TV screen, then press **OK**.
- Use **▲/▼** to select **[Antenna]** for TV channels or **[Cable]** for CATV channels, then press **OK**.

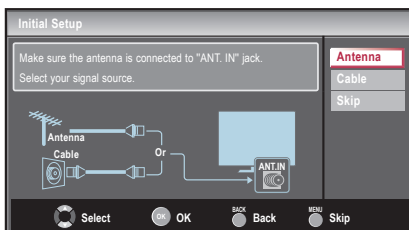

- [Autoprogram]** will begin.

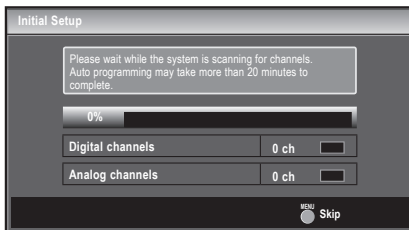

- Use **◀/▶** to select the desired location setting, then press **OK**.

[Home] is ENERGY STAR® qualified setting.

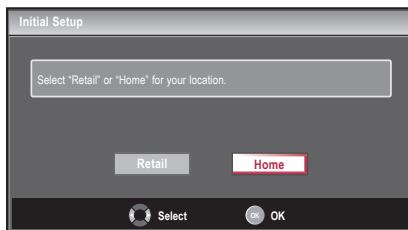

- Select **[Retail]** store, the unit will be set up with predefined setting for retail displays. In this setting, the power consumption may possibly exceed the limited requirement of the ENERGY STAR® qualification.
- Select **[Home]**, the unit is set to maximize the energy efficiency for home setting and it can be adjusted through a choice of picture and sound quality according to your preference.
- When the initial setup is completed, the lowest memorized channel with the confirmation message of the location setting will be displayed on the TV screen.
- You must set **[Home]** in step 4. Otherwise, **[Picture]** and **[Sound]** settings you adjusted will not be memorized after the unit goes into standby mode.

Note

- If you are not receiving a signal from your cable service, contact the Cable provider.
- If you press **⏻** or **MENU** during autoprogram, this setup of TV channels will be canceled.
- The initial autoprogram function can be executed for either **[Antenna]** or **[Cable]** only once. When you change the connection (Antenna/ Cable), set **[Autoprogram]** again. **▶▶ p.21**
- If there is no signal input from the antenna terminal and no operation for several seconds after you turn on the unit, helpful hints appears. Follow the instructions listed on the TV screen.

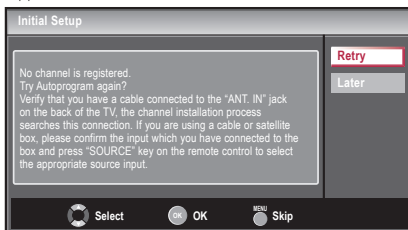

After an initial setup is completed...

- If you want to scan the channels automatically again, **[Autoprogram]** **▶▶ p.21**
- You can add the desired cable and analog channels unmemorized by autoprogram. **[Add Channels]** **▶▶ p.22**
- If you want to change to another language. **[Language]** **▶▶ p.27**
- If you want to change the location setting. **[Location]** **▶▶ p.26**

WATCHING TV

Sleep Timer

can set the unit to go into standby mode after an incremental period of time.

Press **SLEEP** repeatedly to change the amount of time (increases the time by 30 minutes up to 120 minutes).

Press **SLEEP** once to call up the display for checking the remaining time.

- To cancel sleep timer, press **SLEEP** repeatedly until **[Sleep Off]** is displayed.

Sleep 120min.



Switching Each Input Mode can easily switch with the remote control between TV (ATSC or NTSC) and external devices when they are connected to the unit.

Press **SOURCE** or **CH +** repeatedly to cycle through the input modes.

e.g.) 32MD301B/32MD311B/26MD301B/26MD311B



- Pressing **CH -** reverses the direction of the input modes.
- *These may differ depending on what product you purchased. For example, 19MD301B or 19MD311B will be displayed **[HDMI1]**, **[HDMI2]** and **[PC]** instead.



Freeze Mode can freeze the image shown on the TV screen for 5 minutes.

Press **FREEZE** to freeze the image.



- The sound output will not be paused.
- To cancel freeze mode, press any buttons except **Freeze**.

Channel Selection

Select channels by using **CH +/-** or the **Number buttons**.

- To select the memorized channels, use **CH +/-** or the **Number buttons**.
- To select the non-memorized channels, use the **Number buttons**.

11.1

To use the Number buttons

ATSC

- When selecting digital channel 11.1
Be sure to press **.** before entering the subchannel number.



NTSC

- When selecting cable or analog channel 11



Press **PREV CH** to return to the previously viewed channel.

Note

- [No Signal]** will appear on the TV screen after the subchannel broadcast is over;
- [Audio only program]** message will appear on the TV screen, when you receive only sound signal.

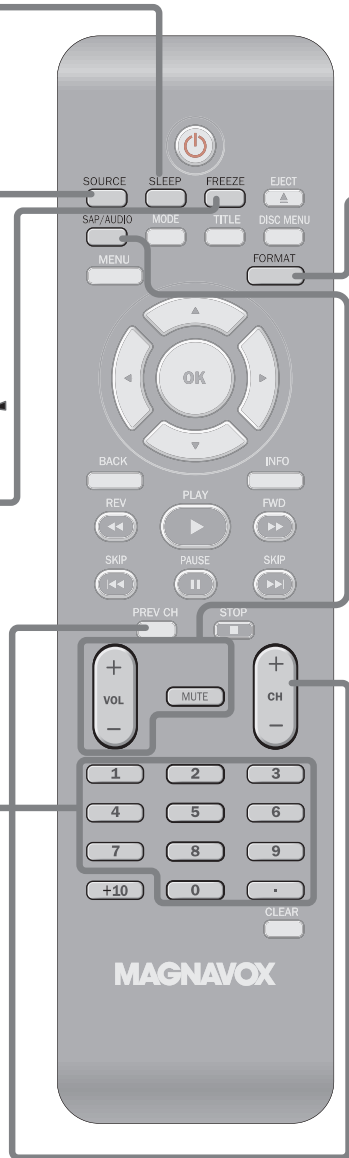

TV Screen Display Mode

5 types of display modes can be selected when the broadcasting station is sending 16:9 or 4:3 video signal. And 3 types of display modes can be selected for PC input signal.

Press **FORMAT** repeatedly to switch the TV aspect ratio.

For 16:9 video signal

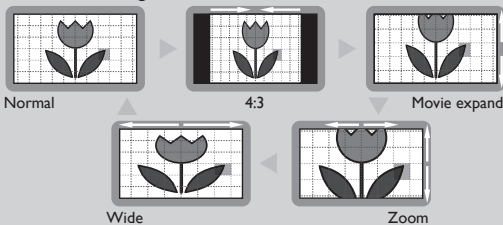

Normal displays a 16:9 picture at its original size.

4:3 displays a 16:9 picture at a 4:3 size; the picture is shortened horizontally. Sidebars appear on both edges of the screen.

Movie expand displays a 16:9 picture that is vertically stretched to fill the screen. This only crops out the top of the picture.

Zoom displays a 16:9 picture at its maximum size without changing its horizontal and vertical ratio.

Wide displays a horizontally stretched picture. This crops out the left and right sides of the picture.

For 4:3 video signal

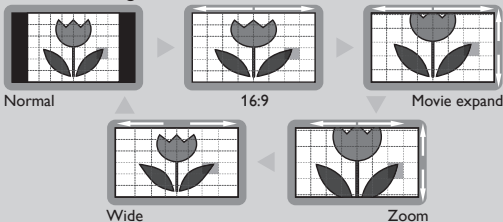

Normal displays a 4:3 picture at its original size. Sidebars appear on both edges of the screen.

16:9 displays a 4:3 picture at a 16:9 size; the picture is stretched horizontally to fill the screen.

Movie expand displays a 4:3 picture at a 16:9 size; the picture is stretched more vertically at the top of the screen. This crops out the top of the picture.

Zoom displays a 4:3 picture at a 16:9 size; at its maximum size that is more vertically stretched to fill the screen. This crops out the top and bottom of the picture.

Wide displays the picture with its center at the original size and the edges stretched horizontally to fill the screen.

For PC input signal through **HDMI1** Input mode

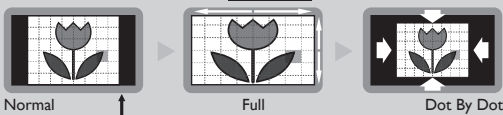

Normal displays a proportionately stretched picture. Sidebars appear on both edges of the screen.

Full displays a picture that is stretched out of proportion horizontally to fill the screen.

Dot By Dot displays a picture in its original size.

*For 19MD301B and 19MD311B, PC input mode is available. They can only accept the PC input signal when the unit is connected to a PC (VGA) Input jack.

Sound Functions

describe how to change the audio or the audio language as well as the volume.



Silence Mode

Press **MUTE** to turn off the sound temporarily.

Mute will be displayed for a few seconds.

- Press **MUTE** again or **VOL +/-** to recover the original volume.

Volume Adjustment

Use **VOL +/-** to adjust the volume.



will be displayed for a few seconds when adjusting the volume.



Switching Audio Mode

ATSC

Press **SAP/AUDIO** repeatedly to cycle through the available audio languages.

- Available languages differ depending on the broadcast.
- **[Other]** is displayed when the audio language cannot be acquired, or the acquired languages are other than English, Spanish or French.



NTSC

Press **SAP/AUDIO** to display the currently selected audio mode. While receiving an MTS broadcast, press repeatedly to cycle through the available audio channel.



e.g.) When all audio are available



STEREO : Outputs stereo-audio

SAP : Outputs second audio program

MONO : Outputs mono-audio

TV Screen Information

You can display the currently selected channel or other information such as the audio mode on the TV screen. In the digital mode, the detailed broadcasting information for the current off the air channel such as program title and program guides are displayed.

- 1 Press **INFO**.

ATSC

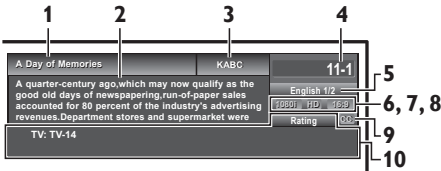

NTSC

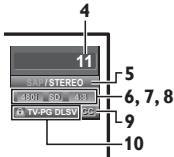

- 1 program title
- 2 program guide
(The program guide added to broadcasting information is displayed to a maximum of 4 lines.)
- 3 broadcast station
- 4 channel number
- 5 audio language (ATSC)/audio mode (NTSC)
[Switching Audio Mode] ▶▶▶ p.17
- 6 effective scanning lines and scan mode
- 7 TV format
- 8 program's image aspect ratio
- 9 CC (not available if closed caption is set to [Off])
- 10 child lock rating

- 2 Press **INFO** or **BACK** to hide the information.

Note

- When the program guide consists of more than 4 lines, use ▲/▼ to scroll to the next/previous lines.
- [No description provided.] is displayed when the program guide is not provided.
- While the program guide is displayed, the closed caption function is interrupted.
- In external input mode, the following screen is displayed; e.g.) When an external device is connected to Video Input jack.



- The information display will automatically disappear in 1 minute.

USING FUNCTIONS

This section describes the overview of the main menu displayed when you press **MENU**.

The main menu consists of the function setting items below.

- 1 Press **MENU** to display the main menu.



- 2 Use **▲/▼** to select a desired menu and an item, then press **OK** to determine the setting.

Picture Page 20

Adjusting the picture mode, or customize the picture quality as your preference.

Sound Page 20

Adjusting the sound mode, equalizer and some other sound functions.

Channel Page 21

Scanning the channels available in your area and see what the antenna levels are.

Features Page 22

Adjusting the Closed Caption, parental guide and some other useful functions.

Language Page 27

You can choose English, Spanish, or French as your on-screen language.

DVD Page 27

You can choose the desired DVD settings.

- 3 When the setting is completed, press **MENU** to exit.

Picture

Before you begin:

You must set [Home] in [Location]. ► p.26

Otherwise, the settings you adjusted will not be memorized after the unit goes into standby mode.

- Use ▲/▼ to select the item you want to adjust, then press OK.

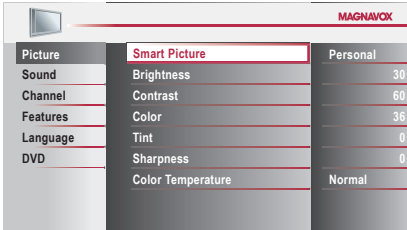

- Adjust the following items.

Smart Picture

Use ▲/▼ to select the desired setting, then press OK. ([Personal], [Standard], [Sports], [Movie], and [Game])

Brightness, Contrast, Color, Tint, Sharpness, Color Temperature

You can only adjust the following options when you set to [Personal] in [Smart Picture].

Use ▲/▼ to select the desired setting, then press OK. Then use ◀/▶ to adjust the setting.

	Cursor ◀	Cursor ▶
Brightness	to decrease brightness	to increase brightness
Contrast	to decrease contrast	to increase contrast
Color	to decrease color intensity	to increase color intensity
Tint	to add red	to add green
Sharpness	to soften	to sharpen
Color Temperature	to add warm colors	to add cool colors

Sound

Before you begin:

You must set [Home] in [Location]. ► p.26

Otherwise, the settings you adjusted will not be memorized after the unit goes into standby mode.

- Use ▲/▼ to select the item you want to adjust, then press OK.

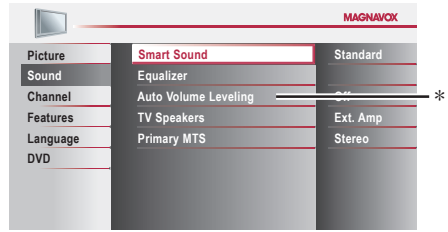

* [Auto Volume Leveling] will only display for 32MD301B, 32MD311B, 26MD301B and 26MD311B.

- Adjust the following items.

Smart Sound

Use ▲/▼ to select the desired setting, then press OK. ([Personal], [Standard], [Movie], [Music], and [News])

Equalizer

Adjust tonal quality for each frequency.

Use ◀/▶ to select the specific frequency and use ▲/▼ to adjust the level, then press OK.

Auto Volume Leveling

This function keeps a constant loudness differential between the TV commercials and the programs.

Use ▲/▼ to select the desired option, then press OK.

On	Reduces volume differences between the TV commercials and the programs.
Off	Removes the auto volume leveling.

TV Speakers

Select the audio output from the unit's speakers, or not. If your amplifier is HDMI link function compatible and connected by an HDMI cable to this unit, some sound operations such as volume up can be changed by using this unit's remote control. Make sure [fun-Link Control] is set to [On]. ► p.26

Use ▲/▼ to select the desired option, then press OK.

On	The sound will be output from the unit's speakers.
Off	The sound will not be output from the unit's speakers.
Ext. Amp	You can control audio output from your connected HDMI link devices by using this unit's remote control.

Note

- We do not guarantee 100% interoperability with other brands of HDMI link compliant devices.

Primary MTS

You can set the output mode as a default for the sound mode (NTSC only).

This setting is not interlocked when you change the output mode by pressing SAP/AUDIO, [Sound Functions] ► p.17

Use ▲/▼ to select the desired option, then press OK.

Stereo	Outputs stereo-audio.
Mono	Outputs mono-audio.
SAP/AUDIO	Outputs second audio program.

Channel

Before you begin:

Make sure the unit is connected to antenna or cable.

- 1 Use **▲/▼** to select the item you want to adjust, then press **OK**.

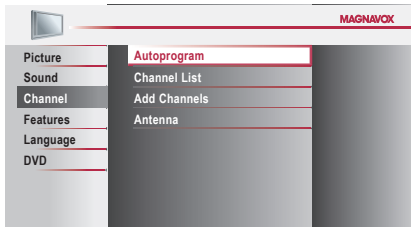

- 2 Adjust the following items.

Autoprogram

If you switch wires (e.g. between antenna and CATV) or if you move the unit to a different area after the initial setting, or if you restore the DTV channels you deleted, it is recommended to use Autoprogram to perform a new channel search.

- 1 Use **▲/▼** to select **[Autoprogram]**, then press **OK**.
- 2 Use **▲/▼** to select an appropriate option, then press **OK**.

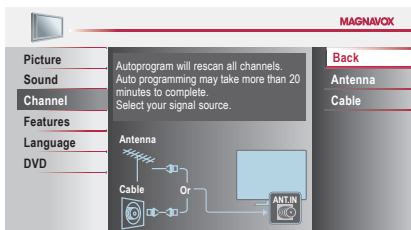

- When connected to VHF/UHF antenna, select **[Antenna]**.
- When connected to CATV, select **[Cable]**.
- **[Autoprogram]** will begin.

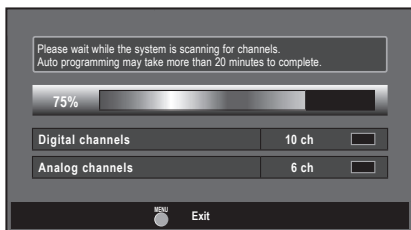

- When the scanning and memorizing are completed, the lowest memorized channel will be displayed.

Note

- After setting **[Autoprogram]**, using **CH +/-** on the remote control skips unavailable programs automatically.
- If you are not receiving a signal from your cable service, contact the Cable provider.
- If you press **⏻** or **MENU** during autoprogram, the setup of TV channels will be canceled.
- Even if **[Autoprogram]** is completed, the channel setting will be lost if the AC power cord is unplugged before the unit goes into standby mode by pressing **⏻**.
- The PIN code will be required once you set a PIN code in the **[Child Lock]**. **▶▶▶ p.23**
- If you want to change your PIN code, follow the instruction of **[Change PIN]**. **▶▶▶ p.25**

Channel List

The channels selected here can be skipped when selecting the channels using **CH +/-**.

Those channels can still be selected with **the Number buttons**.

- 1 Use **▲/▼** to select **[Channel List]**, then press **OK**.
- 2 Use **▲/▼** to select the channel you want to remove, then press **OK**.

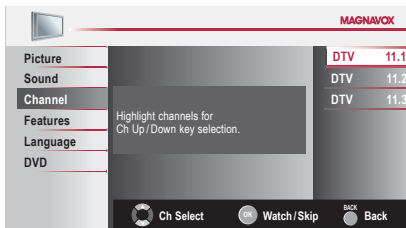

- The channel display for the removed channel darkens. You will not be able to select the channel again using **CH +/-**.
- To reactivate a removed channel, use **▲/▼** and press **OK**. The registered channels are highlighted.
- When you remove a main channel, its subchannels are removed as well.

Note

- The channel with the **[DTV]** indicated on the display is ATSC. Otherwise the channel is NTSC.

Add Channels

This function lets you add the off the air along NTSC or analog Cable channels that were not added by the autoprogram due to reception conditions at the initial setting.

- 1 Use **▲/▼** to select **[Add Channels]**, then press **OK**.
- 2 Use the **Number buttons** to enter the number of the channel you want to add, then press **OK**.

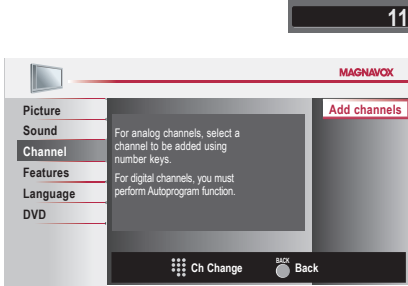

Note

- If setup completes successfully, **[Added to the channel list.]** is displayed.
- If external input is used, it is not possible to register the channel and **[Unavailable]** will be displayed on the TV screen.
- By using **CH +/-**, you can select the memorized channels only.

Antenna Confirmation

ATSC

This function lets you check the digital signal strength of each channel.

- 1 Use **▲/▼** to select **[Antenna]**, then press **OK**.
- 2 Use the **Number buttons** or **CH +/-** to select the channel for which you want to check the digital signal strength.

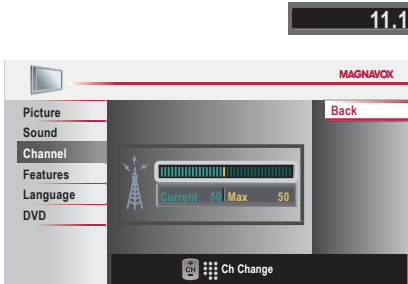

Note

- If the channel is set to analog channel or external input, you cannot confirm the antenna condition.

Features

- 1 Use **▲/▼** to select the item you want to adjust, then press **OK**.

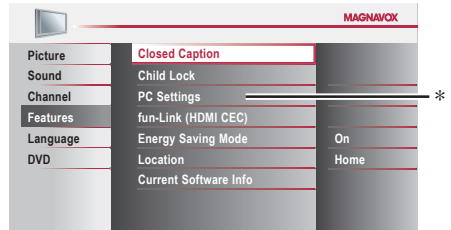

* **[PC Settings]** will only display for 19MD301B or 19MD311B.

- 2 Adjust the following items.

Closed Caption

You can view closed captioning (CC) for TV programs, movies and news. Closed caption refers to text of dialog or descriptions displayed on-screen.

Use **▲/▼** to select **[Closed Caption]**, then press **OK**. See the following description for setting each item.

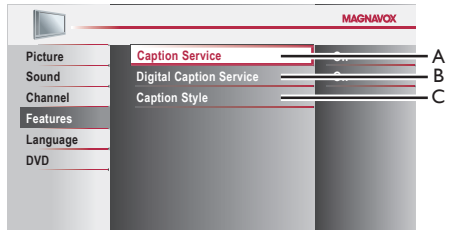

A. Caption Service

- 1 Use **▲/▼** to select **[Caption Service]**, then press **OK**.
- 2 Use **▲/▼** to select the desired closed caption, then press **OK**.

Off	Select if you do not want caption service.
CC-1 and T-1	The primary caption and text services. The captioning or text is displayed in the same language as the program's dialog (up to 4 lines of script on the TV screen, where it does not obstruct relevant parts of the picture).
CC-3 and T-3	Serve as the preferred data channels. The captioning or text is often a secondary language.
CC-2, CC-4, T-2 and T-4	Rarely available and broadcasters use them only in special conditions, such as when [CC-1] and [CC-3] or [T-1] and [T-3] are not available.

- There are 3 display modes according to programs:

Paint-on mode	Displays input characters on the TV screen immediately.
Pop-on mode	Once characters are stored in memory, they are displayed all at once.
Roll-up mode	Displays the characters continuously by scrolling (max. 4 lines).

B. Digital Caption Service

ATSC

In addition to the basic closed caption, DTV has its own closed caption called digital caption service. Use this menu to change the settings for digital caption service.

- Use ▲/▼ to select **[Digital Caption Service]**, then press **OK**.
- Use ▲/▼ to select the desired digital caption service, then press **OK**.

Off	Select if you do not want digital caption service.
CS-1 to CS-6	Select one of these before changing any other item in [Closed Caption] menu. Choose [CS-1] under normal circumstances.

Note

- [Digital Caption Service]** that you can switch differs depending on the broadcast description.

C. Caption Style

ATSC

You can change the caption style such as font, color or size, etc.

- Use ▲/▼ to select **[Caption Style]**, then press **OK**.
- Use ▲/▼ to select **[User Setting]**, then press **OK**.
- Use ▲/▼ to select **[On]**, then press **OK**.
- Use ▲/▼ to select an item, then press **OK**. Then use ▲/▼ to select the desired setting and press **OK**.

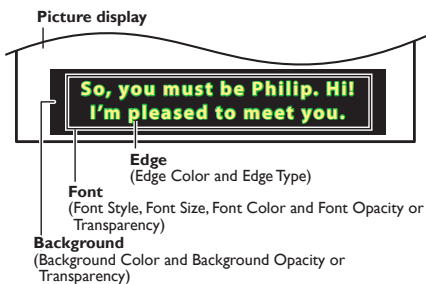

- Review your setting choice made below by looking in the upper right corner of the displayed setting box (not all selections show the differences selected).

Font	Font Style	Closed captioning font style, size, color and opacity can be changed.
	Font Size	
	Font Color	
	Font Opacity	
Background	Background Color	Background color and opacity of the displayed caption can be switched.
	Background Opacity	
Edge	Edge Color	Edge color and type of the displayed caption can be switched.
	Edge Type	

Note

- Closed caption will not be displayed when you are using an HDMI connection.
- To show the closed caption on your TV screen, broadcast signal must contain the closed caption data.
- Not all TV programs and commercials have the closed caption or all types of the closed caption.
- Captions and texts may not exactly match the TV voice.
- Changing channels may delay the closed caption for a few seconds.
- Adjusting or muting the volume may delay the closed caption for a few seconds.
- Abbreviations, symbols and other grammatical shortcuts may be used in order to keep pace with the on-screen action. This is not a malfunction.
- The caption or text characters will not be displayed while the main menu or functions display is shown.
- If a black box appears on the TV screen, this means that the closed caption is set to the text mode. To clear the box, select **[CC-1]**, **[CC-2]**, **[CC-3]**, **[CC-4]** or **[Off]**.
- If the unit receives poor quality television signals, the captions may contain errors, or there might be no captions at all. Some possible causes of poor quality signals are:
 - Automobile ignition noise
 - Electric motor noise
 - Weak signal reception
 - Multiplex signal reception (ghosts or screen flutter)
 - Data dropout and Pixelation (for DTV only)
- The unit retains the closed caption setting if the power fails.
- When the unit receives special effects playback signal (e.g. Search, Slow and Still) from a VCR's video output channel (ch3 or ch4), the unit may not display the correct caption or text.

Child Lock

Child lock reads the ratings for programs, then denies access to the programs which exceed the rating level you set. With this function, you can block certain programs inappropriate for children and any channels or external input modes can be invisible.

- Use ▲/▼ to select **[Child Lock]**, then press **OK**.

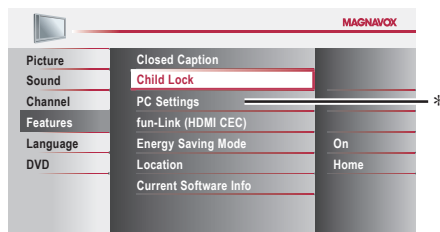

- * **[PC Settings]** will only display for 19MD301B or 19MD311B.

- 2 Use the **Number buttons** to enter the 4-digit number for your **PIN code**.



- When you have not set up your PIN code, enter **0, 0, 0, 0**.
- When the PIN code is correct, **[Child Lock]** menu is displayed.
- See the following description for setting each item.

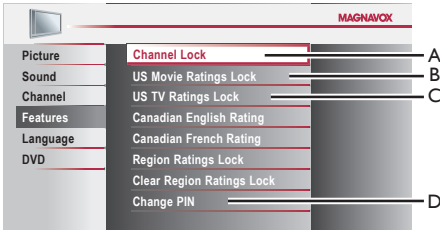

Note

- When you select a rating and set it to **[Block]**, the higher ratings will be blocked automatically. The lower ratings will be available for viewing.
- When you set the highest rating to **[View]**, all ratings turn to **[View]** automatically.
- To block any inappropriate programs, set your limits in **[US Movie Ratings Lock]**, **[US TV Ratings Lock]** and **[Region Ratings Lock]**.
- The child lock setting will be retained after a power failure or after the power is removed for longer than 10 seconds (except the PIN code reverts to 0000). **[Child Lock]** ► p.23
- If the rating is blocked, will appear.
- **[Region Ratings Lock]** will be available when the unit receives a digital broadcast using the new rating system.
- For the United States, the unit may download the Region Ratings Lock Table, if required.
- The Canadian rating systems on this unit are based on CEA-766-A and CRTC policy.

A. Channel Lock

Particular channels or external input modes can be invisible in this function.

- 1 Use **▲/▼** to select **[Channel Lock]**, then press **OK**.
- 2 Use **▲/▼** to select the desired rating, then press **OK** repeatedly to switch between **[View]** and **[Block]**.

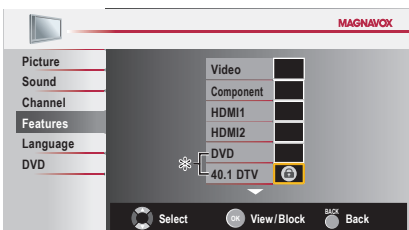

* These may differ depending on what product you purchased. For example, 19MD301B or 19MD311B will be displayed **[PC]** and **[DVD]** instead.

B. Setting US Movie ratings

US Movie ratings lock is the rating system created by MPA.

- 1 Use **▲/▼** to select **[US Movie Ratings Lock]**, then press **OK**.
- 2 Use **▲/▼** to select the desired rating, then press **OK** repeatedly to switch between **[View]** and **[Block]**.

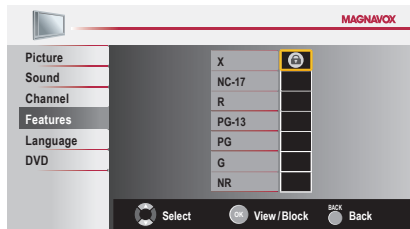

Rating	Category
X	Mature audience only
NC-17	No one under 17 admitted
R	Restricted; under 17 requires accompanying parent or adult guardian
PG-13	Unsuitable for children under 13
PG	Parental guidance suggested
G	General audience
NR	No rating

C. Setting TV ratings

- 1 Use **▲/▼** to select **[US TV Ratings Lock]**, then press **OK**.
- 2 Use **▲/▼ / ◀/▶** to select the desired rating, then press **OK** repeatedly to switch between **[View]** and **[Block]**.

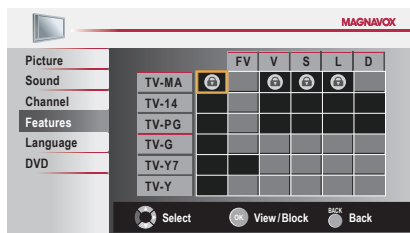

Rating	Category	
TV-MA	Mature audience only	higher
TV-14	Unsuitable for children under 14	↑ ↓
TV-PG	Parental guidance suggested	
TV-G	General audience	
TV-Y7	Appropriate for all children 7 and older	
TV-Y	Appropriate for all children	lower

To set the sub ratings

As for TV-MA, TV-14, TV-PG, or TV-Y7, you can further set the sub ratings to block specific elements of programming. To set the sub ratings, follow the step below.

Use ▲/▼/◀/▶ to select the desired rating, then press **OK** repeatedly to switch between **[View]** and **[Block]**.

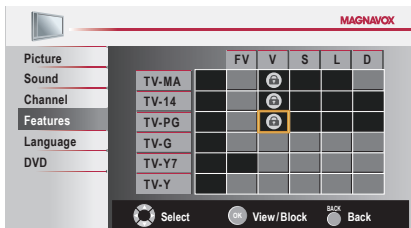

Sub Rating	Category	Rating
FV	Fantasy Violence	TV-Y7
V	Violence	TV-MA TV-14 TV-PG
S	Sexual Situation	TV-MA TV-14 TV-PG
L	Coarse Language	TV-14, TV-PG
D	Suggestive Dialog	TV-14, TV-PG

Note

- Blocked sub rating will appear beside the main rating category in **[US TV Ratings Lock]** menu.
- You cannot block a sub rating (D, L, S or V) if the main rating is set to **[View]**.
- Changing the category to **[Block]** or **[View]** automatically changes all its sub ratings to the same (**[Block]** or **[View]**).

D. Change PIN

Although the default PIN code (0000) is supplied with the unit, you can set your own PIN code.

- Use ▲/▼ to select **[Change PIN]**, then press **OK**.
- Press the **Number** buttons to enter the new 4-digit PIN code.
 - Enter PIN code again in **[Confirm PIN.]** entry field.

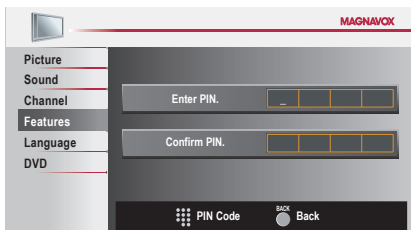

Note

- Make sure new PIN code and confirm PIN code must be exactly the same. If they are different, the space is cleared for reentering.
- Your PIN code will be erased and returns to the default PIN code (0000) when a power failure occurs.
- If you forget the PIN code, unplug the AC power cord then wait for 10 seconds to plug the AC power cord in again. The unit will restore the PIN code to 0000 as the factory default.

PC Settings <19MD301B/19MD311B only>

This function lets you adjust the PC screen position, clock and phase during PC input.

- Use ▲/▼ to select **[PC Settings]**, then press **OK**.
- Use ▲/▼ to select the setting you want to adjust, then press **OK**.

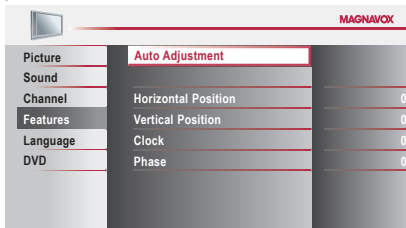

- Adjust the following items.

Auto Adjustment

Use ▲/▼ to select **[Adjust]**, then press **OK**.

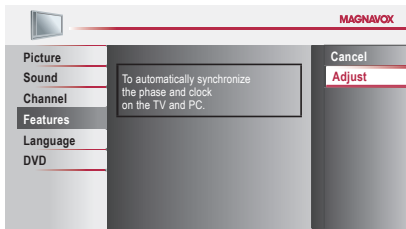

- The horizontal/vertical position, clock and phase of the PC screen are automatically adjusted.

Horizontal Position, Vertical Position

Use ◀/▶ to adjust.

	Cursor ◀	Cursor ▶
Horizontal Position	to move PC screen left	to move PC screen right
Vertical Position	to move PC screen down	to move PC screen up

Clock, Phase

Use ◀/▶ to adjust **[Clock]** setting to stabilize the PC screen and **[Phase]** setting to improve the clarity of the PC screen.

	Cursor ◀	Cursor ▶
Clock	to decrease setting value	to increase setting value
Phase		

Note

- You may not obtain an appropriate screen with **[Auto Adjustment]** for some signals. In this case, adjust the settings manually.
- Adjust **[Phase]** setting after **[Clock]** setting has been properly adjusted.

fun-Link (HDMI CEC)

This function allows you to operate the linked functions between our brand devices with a fun-Link feature and this unit connecting through an HDMI cable.

- 1 Use ▲/▼ to select **[fun-Link (HDMI CEC)]**, then press **OK**.

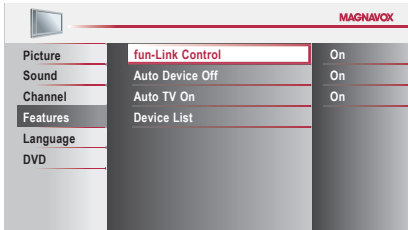

- 2 Use ▲/▼ to select the desired setting, then press **OK**.
- 3 Adjust the following items.

fun-Link Control

Set the fun-Link **[On]** or **[Off]**.

The following additional settings will be grayed out when you set to **[Off]**.

Use ▲/▼ to select the desired setting, then press **OK**.

On	Selects if you have connected an external device that is compatible with the fun-Link function.
Off	Disables all fun-Link.

Auto Device Off

You can set your device to turn off by interlocking from this unit's power.

Use ▲/▼ to select the desired setting, then press **OK**.

On	Your connected fun-Link device turns off automatically when the unit goes into standby mode.
Off	Your connected fun-Link device stays on even if the unit goes into standby mode.

Auto TV On

This unit will turn on detected when the power on signal is sent from your connected fun-Link device.

Use ▲/▼ to select the desired setting, then press **OK**.

On	This unit turns on automatically when you turn on your connected fun-Link device.
Off	This unit stays the standby mode even if you turn on your connected fun-Link device.

Device List

This function lets you see the product model number or name of connected devices.

Use ▲/▼ to select the desired HDMI device listed on the TV screen, then press **OK**.

e.g.) 32MD301B/32MD311B/26MD301B/26MD311B

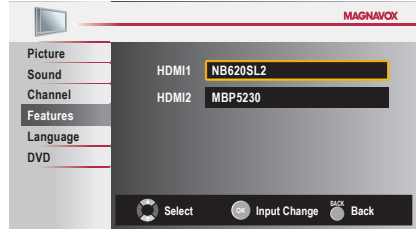

e.g.) 19MD301B/19MD311B

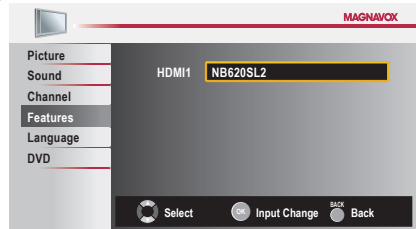

Energy Saving Mode

You can set whether the power consumption is saved or not.

- 1 Use ▲/▼ to select **[Energy Saving Mode]**, then press **OK**.
- 2 Use ▲/▼ to select the desired mode, then press **OK**.

On	Reduces the power consumption.
Off	The power consumption may possibly exceed the limited requirement of the ENERGY STAR® qualification.

Note

- You must set **[Home]** in **[Location]**. ➡ p.26
Otherwise, the settings you adjusted will not be memorized after the unit goes into standby mode.

Location

When you select **[Retail]** store, the power consumption may possibly exceed the limited requirement of the ENERGY STAR® qualification.

- 1 Use ▲/▼ to select **[Location]**, then press **OK**.
- 2 Use ▲/▼ to select the desired location, then press **OK**.

Retail	The unit will be set up with predefined setting for retail displays. In this setting, the power consumption may possibly exceed the limited requirement of the ENERGY STAR® qualification.
Home	This setting is ENERGY STAR® qualification. The unit is set to maximize the energy efficiency for home setting and it can be adjusted through a choice of picture and sound quality according to your preference.

Current Software Info

This function shows what version of the software currently used.

- 1 Use ▲/▼ to select **[Current Software Info]**, then press **OK**.
- 2 Confirm the version of the software currently used.

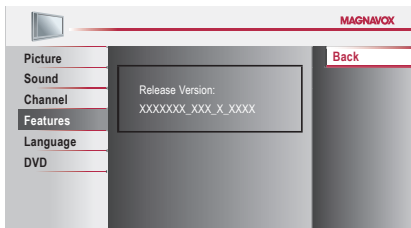

Language

Use ▲/▼ to select **[English]**, **[Español]** or **[Français]**, then press **OK**.

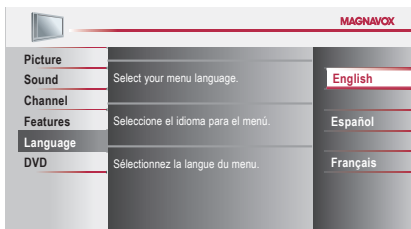

Note

- If you need the English menus instead of the Spanish or French menus, press **MENU**. Use ▲/▼ to select **[Idioma]** or **[Langue]**, then press **OK**. Use ▲/▼ to select **[English]**, then press **OK**. Press **MENU** to exit the main menu.

DVD

Settings are only effective when the unit is in DVD mode and any discs should not be played back.

- 1 Use ◀/▶ to select a desired setting and an item, then press **OK** to determine the setting.

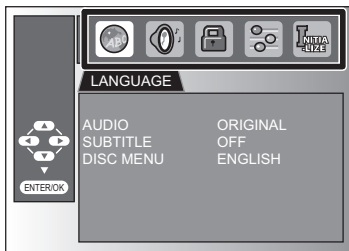

- 2 When the setting is completed, press **MENU** to exit.

DVD Language Setting

You can change the desired language when playing back the disc.

- 1 Use ▲/▼ to select the item you want to adjust, then press **OK**.
- 2 Adjust the following items.

AUDIO *1, *2 (Default: ORIGINAL)

Select the desired audio language.

SUBTITLE *1, *2 (Default: OFF)

Select the desired subtitle language.

DISC MENU *1 (Default: ENGLISH)

Select the desired language in DVD menu.

Note

- To change the on-screen language, call up **[Language]** from the main menu and set the desired language. **[Language]** ► p.27
- *1**
 - Language options are not available with some discs.
 - If **[OTHER]** is selected in **[AUDIO]**, **[SUBTITLE]** or **[DISC MENU]** menu, press 4-digit number to enter the code for the desired language. **[Language Code List]**. ► p.29
 - Only the languages supported by the disc can be selected.
- *2**
 - Language setting for Audio and Subtitle are not available with some discs.
 - Use **MODE** to select subtitles available on the DVD.
 - Use **SAP/AUDIO** to select audio available on the DVD.
 - If the DVD's default settings for audio and subtitle are the same language, the subtitles may not show unless you turn them on.

DVD Audio Setting



Choose the appropriate audio settings for your equipment. It only affects during the playback of DVD.

- Use **▲/▼** to select the desired item, then press **OK**.

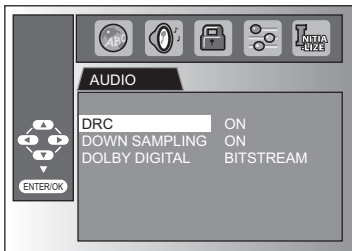

- Adjust the following items.

DRC (dynamic range control) (Default: ON)

This function is available only on the discs which are recorded in the Dolby Digital format.

ON	Compress the range between soft and loud sounds.
OFF	No effects (original sound).

DOWN SAMPLING (Default: ON)

This function is available only on digital outputting of a disc recorded in 96kHz.

ON	When outputting in 48kHz.
OFF	When outputting the original sound.

Note

- When playing back a 96 kHz disc with the copyright protection or when **[Virtual Surround]** is set to **[1]** or **[2]**, the sound will be down sampled at 48 kHz even if the **[DOWN SAMPLING]** is set to **[OFF]**. **[Virtual Surround]**. ►► p.35

DOLBY DIGITAL (Default: BITSTREAM)

Set to **[BITSTREAM]** when this unit is connected to a Dolby Digital decoder.

BITSTREAM	Outputs Dolby Digital signals.
PCM	Converts the Dolby Digital into PCM. (2 channel)

Parental Setting



Parental setting prevents your children from viewing inappropriate materials. (password protected.) Playback will stop if the ratings exceed the levels you set.

- Use **the Number buttons** to enter the 4-digit password for your password, then press **OK**.



- If you have set password already, use **the Number buttons** to enter the current 4-digit password.
- You cannot use the default password (4737) to play back a DVD.

- Use **▲/▼** to select the **[PARENTAL LEVEL]**, then press **OK**.

- Use **▲/▼** to select the desired item, then press **OK**.

PARENTAL LEVEL	
ALL	All parental locks are cancelled.
8 [ADULT]	All ratings (adult/general/children) can be played back.
7 [NC-17]-2 [G]	Only DVD intended for general use and children can be played back.
1 [KID SAFE]	Only DVD intended for children can be played back.

To change the password

- At step 2, use **▲/▼** to select **[PASSWORD CHANGE]** then press **OK**.

- Use **the Number buttons** to enter the new 4-digit password.

Note

- DVD-video may not respond to parental lock settings. Make sure this function works with your DVD-video.
- Record the password in case you forget it.
- If you forget the password, press **4, 7, 3, 7**, then enter your new password. Password will be cleared and parental levels will be set to **[ALL]**.
- A power failure will not erase your password.

Others

You can change the other functions.

- 1 Use ▲/▼ to select the desired item, then press OK.

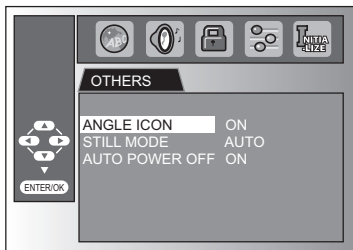

- 2 Adjust the following items.

ANGLE ICON (Default: ON)

Set to [ON] to show the angle icon when multiple camera angles are available during DVD playback.

STILL MODE (Default: AUTO)

Set the picture quality in the still mode. If you select [AUTO], it automatically selects the best resolution setting ([FRAME] or [FIELD]) based on the date characteristics of the pictures.

FIELD	The picture in the still mode will be stabilized.
FRAME	The picture in the still mode will be highly defined.

AUTO POWER OFF (Default: ON)

Set to [ON] if there is no operation for 20 minutes, the unit goes into standby mode.

Reset to the Default Setting

You can reset all the settings except for the parental setting and on-screen menu language.

- 1 Use ▲/▼ to select [YES], then press OK.

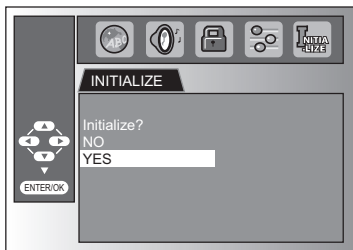

Note

- When you want to cancel the initialization, select [NO], then press OK.

Language Code List









Language	Code	Language	Code
A-B			
Abkhazian	4748	Lithuanian	5866
Afar	4747	Macedonian	5957
Afrikaans	4752	Malagasy	5953
Albanian	6563	Malay	5965
Amharic	4759	Malayalam	5958
Arabic	4764	Maltese	5966
Armenian	5471	Maori	5955
Assamese	4765	Marathi	5964
Aymara	4771	Moldavian	5961
Azerbaijani	4772	Mongolian	5960
Bashkir	4847	Nauru	6047
Basque	5167	Nepali	6051
Bengali; Bangla	4860	Norwegian [NOR]	6061
Bhutani	5072		O-R
Bihari	4854	Occitan	6149
Bislama	4855	Oriya	6164
Breton	4864	Oromo(Afan)	6159
Bulgarian	4853	Panjabi	6247
Burmese	5971	Pash-to; Pushto	6265
Byelorussian	4851	Persian	5247
		Polish [POL]	6258
C-E			
Cambodian	5759	Portuguese [POR]	6266
Catalan	4947	Quechua	6367
Chinese [CHI]	7254	Rhaeto-Romance	6459
Corsican	4961	Romanian [RUM]	6461
Croatian	5464	Russian [RUS]	6467
Czech [CZE]	4965		S
Danish [DAN]	5047	Samoan	6559
Dutch [DUT]	6058	Sangho	6553
English [ENG]	5160	Sanskrit	6547
Esperanto	5161	Scots Gaelic	5350
Estonian	5166	Serbian	6564
		Serbo-Croatian	6554
F-H			
Faroese	5261	Sesotho	6566
Fiji	5256	Setswana	6660
Finnish [FIN]	5255	Shona	6560
French [FRE]	5264	Sindhi	6550
Frisian	5271	Singhalese	6555
Galician	5358	Siswat	6565
Georgian	5747	Slovak	6557
German [GER]	5051	Slovenian	6558
Greek [GRE]	5158	Somali	6561
Greenlandic	5758	Spanish [SPA]	5165
Guarani	5360	Sundanese	6567
Gujarati	5367	Swahili	6569
Hausa	5447	Swedish [SWE]	6568
Hebrew	5569		T
Hindi	5455	Tagalog	6658
Hungarian [HUN]	5467	Tajik	6653
		Tamil	6647
I-K			
Icelandic [ICE]	5565	Tatar	6666
Indonesian	5560	Telugu	6654
Interlingua	5547	Thai	6654
Interlingue	5551	Tibetan	4861
Inupiak	5557	Tigninya	6655
Irish [IRI]	5347	Tonga	6661
Italian [ITA]	5566	Tsonga	6665
Japanese [JPN]	5647	Turkish [TUR]	6664
Javanese	5669	Turkmen	6657
Kannada	5760	Twi	6669
Kashmiri	5765		U-Z
Kazakh	5757	Ukrainian	6757
Kinyarwanda	6469	Urdu	6764
Kirghiz	5771	Uzbek	6772
Kirundi	6460	Vietnamese	6855
Korean [KOR]	5761	Volapuk	6861
Kurdish	5767	Welsh	4971
		Wolof	6961
L-N			
Laothian	5861	Xhosa	7054
Latin	5847	Yiddish	5655
Latvian; Lettish	5868	Yoruba	7161
Lingala	5860	Zulu	7267

Note

- If you choose a language that has a 3-letter abbreviation, the code will be displayed every time you change the audio or subtitle language setting above. If you choose any other language, [---] will be displayed instead. (3-letter abbreviation is written in bracket.)

OPERATING DVD

Playable Media

Media Type	Logo	Recorded Signal	Media Size
DVD-VIDEO	 	digital video (MPEG2)	5 inches (12 cm)
DVD-RW	 		
DVD-R	 		
CD-DA		digital audio	
CD-RW	 		
CD-R	 		

Region Codes

This unit has been designed to play back DVD with region 1. DVD must be labeled for ALL regions or for region 1 in order to play back on the unit. You cannot play back DVD that are labeled for other regions. Look for the symbols on your DVD. If these region symbols are not on your DVD, you cannot play back the DVD in this unit.



The number inside the globe refers to region of the world. A DVD labeled for a specific region can only be played back on the unit with the same region code.

Color Systems

DVD is recorded in different color systems throughout the world. The most common color system is NTSC (which is used primarily in the United States and Canada).

This unit uses NTSC, so DVD you play back must be recorded in the NTSC system. You cannot play back DVD recorded in PAL color systems.

Unplayable Media

NEVER play back the following discs. Otherwise, malfunction may result!

- 3 inches (8 cm) disc
- DVD-RAM
- DVD-audio
- CD-i
- Photo CD
- Video CD
- DVD with region codes other than 1 or ALL
- DTS-CD
- DVD-ROM for personal computers
- CD-ROM for personal computers
- The discs with labels, scratches, stains, blemishes, etc.
- HD DVD
- Blu-ray Disc
- DVD or CD contains MP3/JPEG files
- KODAK Picture CD

On the following disc, the sound MAY NOT be heard.

- Super audio CD

Any other discs without compatibility indications

Note

- Unfinalized discs cannot be played back.
- For DVD-RW/-R, discs recorded in the VR (video recording) format cannot be played back. Only the finalized video format discs can be played back.
- Some discs cannot be played back because of incompatible recording conditions, characteristics of the recorder or special properties of discs.
- Only the sound recorded on the normal CD layer can be delivered. The sound recorded on the high density super audio CD layer cannot be delivered.
- Do not use a single CD adaptor which makes 3 inches (8 cm) to 5 inches (12 cm) disc.
- You can play back discs with the marks listed in [Playable Media]. If you use non-standardized discs, this unit may not play them back or the sound and video quality will be compromised.
- If the recorded portion of the disc is too small (less than 2.17 inches (55 mm) across), it may not play back properly.

These operations are accessible by remote control. Some may also be accessible by controls on the main unit.

Playback

Before you begin:

Turn on the amplifier and any other equipment which is connected to this unit. Make sure the external audio receiver (not included) are set to the correct channel.

- 1 Press  to turn on the unit.
- 2 Insert a disc with label facing forward.
<32MD301B/32MD311B>





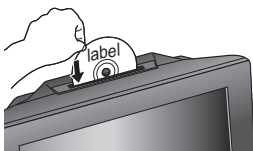

<26MD301B/26MD311B/19MD301B/19MD311B>





CAUTION

- Do not put coins or foreign objects into the disc loading slot.

- In case the DVD was recorded on both sides, make sure the label of the side you want to play back is facing forward.
- 3 The unit switches to the DVD mode when the unit was in TV mode and detects the type of disc.
 - Press **PLAY**  if the unit does not go to the DVD mode.
 - 4 The unit starts playback.
 - If playback does not start automatically, press **PLAY**  again.
 - 5 Press **STOP**  to stop playback temporarily.
 - If playback remains stopped for 20 minutes, the unit will go into standby mode automatically when **[AUTO POWER OFF]** is set to **[ON]**.
 - 6 Press **EJECT**  to eject the disc.

Note

- **[⊙]** may appear at the top-right on the TV screen when the operation is prohibited by the disc or this unit.
- Some DVD may start playback from title 2 or 3 due to specific programs.
- During the playback of a 2-layered disc, pictures may stop for a moment. This happens while the 1st layer is being switched to the 2nd layer. This is not a malfunction.
- When you cannot remove the disc, you may try either following operations.
 - Press and hold **EJECT**  on the unit for more than 5 seconds.
 - Unplug the AC power cord and plug it in again, then press **EJECT** .

It will take about 10 seconds to eject the disc, while that the unit will not respond to any key commands.

Disc Menu

DVD

Some discs contain disc menus which describe the contents of the disc or allow you to customize disc playback, or title menu which lists the titles available on the DVD.

To display the DVD menu, press **DISC MENU** and use **▲/▼/◀/▶** to select an item, then press **OK** (or **PLAY** ).

To display the top menu, press **TITLE** and use **▲/▼/◀/▶** to select an item, then press **OK** (or **PLAY** .

Note



- Menu operations may vary depending on the disc. Refer to the manual accompanying the disc for more details.

Resume Playback

Press **STOP**  during playback. Resume message will appear on the TV screen.

Press **PLAY** . Playback will resume from the point at which playback was stopped.

Note

- To cancel resume, press **STOP**  one more time in the stop mode. On some discs, **STOP**  will not work while the resume message appears. Please wait until the message disappears.
- The resume information will be kept even when the unit goes into standby mode. However, ejecting the disc will cancel the resume feature. Playback will start at the beginning the next time you insert the disc.

Paused and Step-by-step Playback

Press **PAUSE**  during playback.

- Playback will be paused and sound will be muted.

DVD

Each time you press **PAUSE**  in the pause mode, the disc goes forward one frame at a time.

To continue playback, press **PLAY** .

Note

- Set **[STILL MODE]** to **[FIELD]** in the **[OTHERS]** menu if pictures in the pause mode are blurred.  p.29

Fast Forward / Fast Reverse

Press **FWD**  or **REV**  repeatedly during playback to select the desired forward or reverse speed.

To continue playback, press **PLAY** .

Note

- Set **[STILL MODE]** to **[FIELD]** in the **[OTHERS]** menu if pictures in the fast playback mode are blurred.  p.29
- Fast forward/fast reverse speed varies with disc. Approximate speed is 1(2x), 2(8x), 3(20x), 4(50x) and 5(100x) on DVD and 1(2x), 2(8x) and 3(30x) on audio CD.
- For DVD, sound will be muted during this function.
- For audio CD, sound will be intermittent during the search.

Slow Forward/Slow Reverse

DVD

Press **FWD** ►► or **REV** ◀◀ repeatedly during the paused mode to select the desired forward or reverse speed.
To continue playback, press **PLAY** ►.

Note

- Set **[STILL MODE]** to **[FIELD]** in the **[OTHERS]** menu if pictures in the slow playback mode are blurred. ►► p.29
- Slow forward/slow reverse speed varies with disc. Approximate speed is 1(1/16x), 2(1/8x) and 3(1/2x).
- The sound will be muted during this function.

Zoom

DVD

The zoom function allows you to enlarge the video image and to pan through the enlarged image.

- 1 During playback, press **MODE** repeatedly until **[ZOOM]** appears.
 - The picture becomes twice as large.
- 2 Press **OK** repeatedly to change the zoom factor; **[2x]** or **[4x]**.
- 3 Once a desired zoom factor is set, use **▲/▼/◀/▶** to slide the zoomed picture across the TV screen.
- 4 To exit zoom, repeat steps 1 to 2 above and press **OK** repeatedly until **[OFF]** appears.

Note

- The gray box with an inner blue box that shows during zoomed playback is the position guide indicates the position of the zoomed image within the overall image.
Position guide stays on the TV screen until you press **OK**. Press **OK** one more time to recall the position guide when disappears.
- Zoom function does not work while the disc menu is displayed.
- 4x zoom is not available on some discs.
- Zoom function is also available during pause mode.

Search Functions

Chapter/Title/Track Search

You can select chapters, titles or tracks on the disc.

- 1 During playback, press **MODE** repeatedly until **[CH]** / **[TT]** / **[TR]** appears.
 - If you want to perform the title search, use **▲/▼** repeatedly until **[TT]** appears.
- 2 Press the **Number buttons** to select your desired chapter, title or track within 60 seconds.
To play back a single-digit chapter, title or track when there are more than 10 chapters, titles or tracks, press **OK** after entering the chapter, title or track number.
- 3 Playback will start automatically from the chapter, title or track you selected.

Note

- Chapter, title or track search can only be performed during playback or when the unit has kept the resume information. It cannot be performed in the stop mode.
- The total number of chapters/titles/tracks in your disc; with less than 10 chapters/titles/tracks, press the chapter/title/track number directly; To play a double-digit chapter/title/track, press the chapter/title/track number.
- Track search is not available for programmed or random playback.

Using SKIP ◀◀/►►

- 1 During playback, press **SKIP** ◀◀/►► repeatedly until a desired chapter, title or track will be selected.

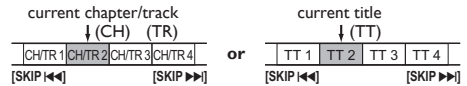

- 2 Playback will start automatically from the chapter, title or track you selected.

Note

- **SKIP** ◀◀/►► are not available when playback is stopped.

Time Search

You can select the desired time which the disc is played back from.

- 1 During playback, press **MODE** repeatedly until **[TIME]** / **[TIME]** appears.
- 2 Use **▲/▼** repeatedly until **[CL]** appears.
- 3 Press the **Number buttons** to select your desired time lapse within 60 seconds.
- 4 Playback will start automatically from the time you selected.

Note

- When there is no need to enter a number, **[0]** appears automatically. For example, **[0:0: _ _]** appears in the time search menu if the total time of the title or track is less than 10 minutes.
- Press **CLEAR** to erase the incorrect input at step 3.
- Time search can only be performed during playback or when the unit has kept the resume information.
It cannot be performed in the stop mode.

Direct Search

Press the **Number buttons** to select your desired chapter, title or track.

Note

- To select a single-digit chapter, title or track number, press the number directly.
- To select double digit chapter, title or track number:
 - If the disc contains more than 9 and less than 100 chapter, title or track, press **+10** first, then enter the double digit chapter, title or track number;
 - (e.g., for track 26, press **+10, 2 and 6**)

Repeat Playback

Repeat function is available only during playback.

- 1 During playback, press **MODE** repeatedly until [] appears.
- 2 Press **▲/▼** to change the repeat mode.

DVD

OFF	repeat off
CHAPTER	current chapter repeat
TITLE	current title repeat



CD

OFF	repeat off
TRACK	current track repeat
ALL	entire disc repeat

- 3 Press **BACK** to exit.

Repeat A-B Playback

You can repeat playback between A and B on a disc.

- 1 During playback, press **MODE** repeatedly until [] appears.
- 2 Press **OK** at your desired starting point (A).
- 3 Press **OK** at your desired ending point (B).
 - Point B should be in the same title or track as point A.
 - Within a few seconds, the section A-B will begin to play back repeatedly.
- 4 To cancel repeat A-B playback, press **MODE** repeatedly until [] appears. Press **OK** so [**OFF**] appears.

Note

- Repeat setting (except [**ALL**]) will be cleared when moving to another title or chapter; track.
- During programmed playback, repeat setting will be effective for the tracks in the program.
- Repeat playback or repeat A-B playback may not available with some discs.
- Repeat A-B playback does not function during other repeat mode.
- To cancel point A, press **CLEAR** at step 2 in [**Repeat A-B Playback**].
- Stopping playback will cancel repeat A-B playback.





Random Playback

CD

This function shuffles the playing order of tracks instead of playback in the sequence.

- 1 In stop mode, press **MODE** repeatedly until [**RANDOM**] menu appears.
- 2 Press **PLAY ►** to start random playback.

Note

- To repeat the current track in the random mode, follow the steps 1 and 2 in [**Repeat Playback**] and select [ **TRACK**].  p.33
- To repeat the entire random selections, follow the steps 1 and 2 in [**Repeat Playback**] and select [ **ALL**].  p.33



Programmed Playback

CD

You may determine the order in which tracks will play back.

- 1 In stop mode, press **MODE** repeatedly until [**PROGRAM**] menu appears.
- 2 Use **▲/▼** to select a desired track, then press **OK** to store.
 - Additional tracks may be on other screens. Use **▲/▼** to go on to the next/previous pages.
 - Repeat this step until you have selected all the tracks you wish to play back in the program.
 - Up to 99 tracks can be ordered.
 - If 8 or more tracks were in a program, use **SKIP ◀◀/▶▶** to see all the tracks.
- 3 Press **PLAY ►** to start programmed playback.

Note

- Press **CLEAR** to erase the last track in the program if you make an error.
- To erase all programmed tracks at once, select [**ALL CLEAR**] and press **OK** at step 2.
- While a program is being played back, **STOP ■** works as follows:
 - Pressing **STOP ■** once: The track will be in the resume standby mode. Next time you press **PLAY ►**, the playback will resume from the point where it is stopped in the programmed playback.
 - Pressing **STOP ■** twice: Resume mode will be canceled. Next time you press **PLAY ►**, playback will restart from the first track in the original order. However, your programmed playback can be restarted when you follow the above steps. (Your programs are still stored until either the disc is ejected or the unit goes into standby mode.)
 - On some discs, **STOP ■** will not work while the resume message appears. Please wait until the message disappears.
- To repeat the current track in the program, follow the steps 1 and 2 in [**Repeat Playback**] and select [**TRACK**].  p.33
- To repeat the entire program, follow the steps 1 and 2 in [**Repeat Playback**] and select [**ALL**].  p.33
- Ejecting the disc or the unit goes into standby mode will erase the program.
- You cannot use the **Number** buttons to select another track during programmed playback. Use **SKIP ◀◀/▶▶** to select other tracks in the program.
- You cannot combine random playback with programmed playback.
- You cannot alter a programmed order during playback.
- You can start programmed playback only while in [**PROGRAM**] menu.

On-screen Display

You can check the information about the current disc by pressing **INFO** on the remote control.

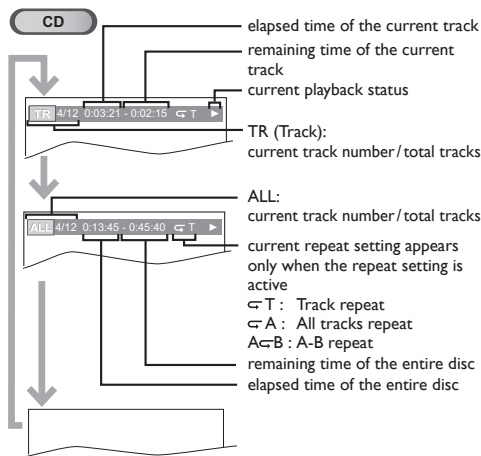
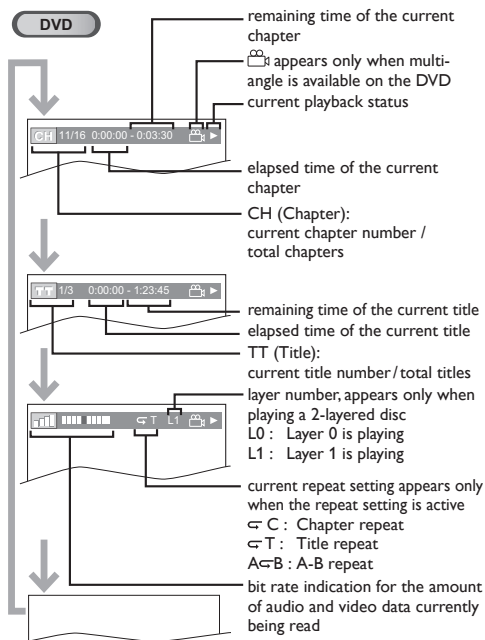

Note

- When you are playing back an audio CD in program or random mode, [**TR** PROGRAM] (or [**TR** RANDOM]) will be displayed instead of [**2**].

Special Settings

Subtitle Language

DVD

This unit allows you to select a subtitle language (if available) during DVD playback.

- During playback, press **MODE** repeatedly until [**Ⓜ**] appears.
- Use **▲/▼** repeatedly until your desired language appears.

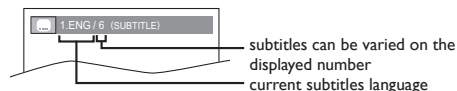

- Each time you press **▲/▼**, the subtitle language changes as follows.

OFF	no subtitles
ENG	English audio
SPA	Spanish audio

- Press **BACK** to exit.

Note

- To cancel the subtitle, select [**OFF**] at step 2.
- If your language is not shown after pressing **▲/▼** several times, the disc may not have that language. However, some discs allow you to change subtitle languages setting in the disc menu. (Operation varies depending on the disc, so refer to the manual along with the disc.)
- When [**NOT AVAILABLE**] appears on the TV screen, it means no subtitle is recorded on the scene.
- If you choose a language that has 3-letter-language code, the code will be displayed every time you change the subtitle language setting. If you choose any other languages, [---] will be displayed instead. **▶▶▶ p.29**
- Ejecting the disc will cancel your subtitle setting.

Audio Language

DVD

This unit allows you to select an audio language (if multiple languages are available) during DVD playback.

- During playback, press **SAP/AUDIO** repeatedly until the desired language appears.

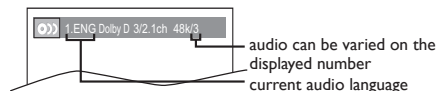

- Each time you press **SAP/AUDIO**, the audio language changes as follows.

ENG	English audio
SPA	Spanish audio
FRE	French audio

Note

- Some discs will only allow you to change the audio setting from the disc menu. Refer to the manual accompanying the discs for details.
- If your language is not shown after pressing **SAP/AUDIO** several times, the disc may not have that language. However, some discs allow you to change multiple audio languages setting in the disc menu. (Operation varies depending on the disc, so refer to the manual along with the disc.)
- When **[NOT AVAILABLE]** appears on the TV screen, it means audio language is not available.

STEREO	Stereo sound with left and right channels.
L-ch	Left channel sound only.
R-ch	Right channel sound only.

Note

- Virtual surround cannot be changed when the sound mode is set to either **[L-ch]** or **[R-ch]**.

Virtual Surround

You can enjoy virtual surround on your 2 channel stereo system.

- During playback, press **MODE** repeatedly until **[]** appears.
- Press **▲/▼** to select the sound level.

1	Natural effect.
2	Emphasized effect.
OFF	No effects (original sound).

- Press **BACK** to exit.

Note

- The setting will be kept even if the unit is turned off.
- For audio CD, virtual surround will not be effective if the sound mode is set to something other than **[STEREO]**. **[Stereo Sound Mode]**. ►► p.35
- Turn down the level or select **[OFF]** if the sound is distorted.

Marker Setup

This feature allows you to assign a specific point on a disc to be called back later:

To set a marker

- During playback, press **MODE** repeatedly until **[]**/**[]** appears.
- Use **▲/▼** repeatedly until marker search menu appears.
- Use **◀▶** to select an available marker within 60 seconds.
- When the playback reaches the point at which you want to set a marker, press **OK**.
 - Marker is now set.
- Press **BACK** to exit.

To return to the marker later

- Repeat steps 1-2 in **[To set a marker]**. Use **◀▶** to select the desired marker.
- Press **OK** at the desired marker to restart playback from the specific point which you set.

Note

- Marker search menu will disappear in about 60 seconds when there is no input.
- You can mark up to 10 points.
- To clear a marker, select the marker to be cleared, and then press **CLEAR**.
- Ejecting the disc or turning off the power will erase all markers.
- Selecting **[]** at step 3 in the section **[To set a marker]** will also erase all markers.

Camera Angles

DVD

Some DVD may contain scenes which have been shot simultaneously from various angles. You can change the camera angle if **[]** appears on the screen. If **[ANGLE ICON]** is set to **[OFF]** in **[OTHERS]** menu, **[]** will not appear. ►► p.29.

- During playback, press **MODE** repeatedly until **[]** appears.
- Use **▲/▼** repeatedly until your desired camera angle appears.

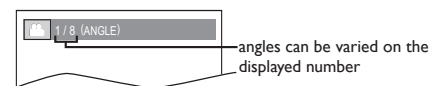

- Press **BACK** to exit.

Black Level Setting

DVD

Adjust the black level to make the dark areas of the TV picture brighter.

- During playback, press **MODE** repeatedly until **[]** appears.
- Press **▲/▼** to adjust the black level.

ON	Makes the dark areas brighter.
OFF	Shows the original picture as recorded.

- Press **BACK** to exit.

Note

- The setting will be kept even if the unit goes into standby mode.

Stereo Sound Mode

CD

This unit allows you to select a sound mode during CD playback.

- During playback, press **SAP/AUDIO** repeatedly until the desired sound mode appears.
- Each time you press **SAP/AUDIO**, the sound mode changes as follows.

CONNECTING DEVICES

No supplied cables are used with these connections:

- Please purchase the necessary cables at your local store.

Before you connect:

Be sure other device is connected properly before plugging in the AC power cord.

External Device Connection

HDMI Connection

HDMI connection offers the highest picture quality.

HDMI (High-Definition Multimedia Interface) transports high definition digital video and multi-channel digital audio through a single cable.

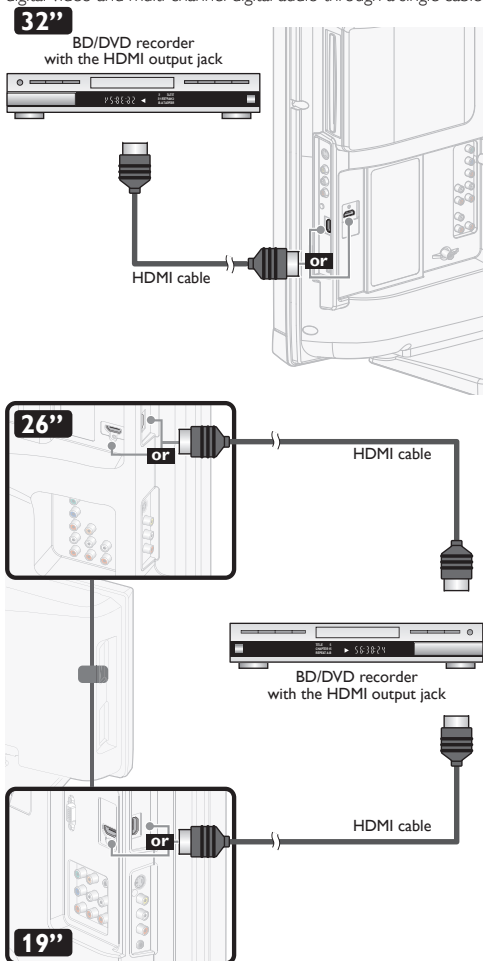

HDMI-DVI Connection

Use an HDMI-DVI conversion cable to connect the unit to external video devices equipped with DVI output jack. (Use HDMI 1 Input jack only and Audio L/R below HDMI 1 Input jack on rear of TV.)

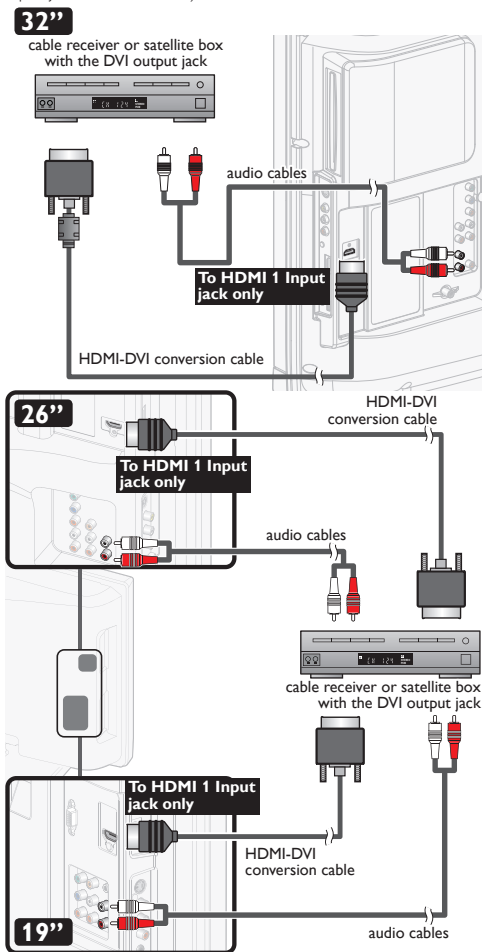

Note

- Use an HDMI cable with the HDMI logo (a certified HDMI cable). High Speed HDMI cable is recommended for the better compatibility.

For HDMI connection (use HDMI 1 or 2 Input jack)

- The unit accepts 480i, 480p, 720p, 1080i and 1080p 24/30/60 Hz of video signals, and 32kHz, 44.1kHz and 48kHz of audio signals.
- This unit accepts 5.1 channel audio signal (Dolby Digital) and 2 channel audio signal (LPCM).
- This unit accepts only signals in compliance with EIA/861.

For HDMI-DVI connection

- The unit accepts 480i, 480p, 720p, 1080i and 1080p video signals.
- HDMI-DVI connection requires separate audio connections as well and the audio signals are converted from digital to analog.
- DVI does not display 480i image which is not in compliance with EIA/CEA-861/861B.

Component Video Connection

Component Video connection offers better picture quality for video devices connected to the unit.

If you connect to the unit's Component Video Input jacks, connect Analog Audio cables to the Analog Audio L/R Input jacks for the Component Video connector jacks.

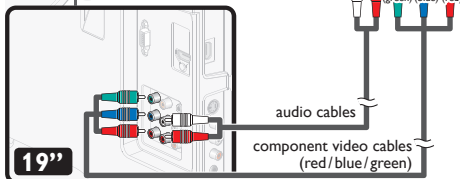
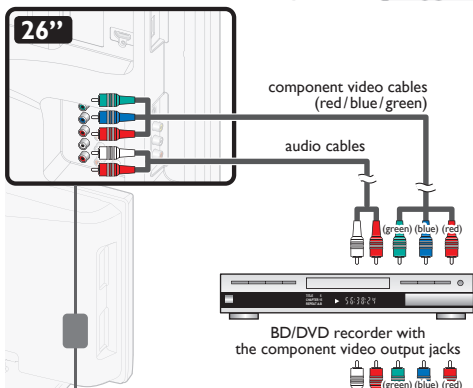
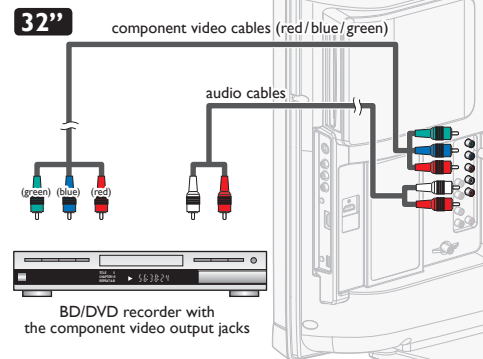

Note

- The unit accepts 480i/480p/720p and 1080i of video signals for this connection.

S-Video Connection

S-Video connection offers good picture quality for video devices connected to the unit.

If you connect to the unit's S-Video Input jack, connect audio cables to the Audio L/R jacks below the Composite Video connector:

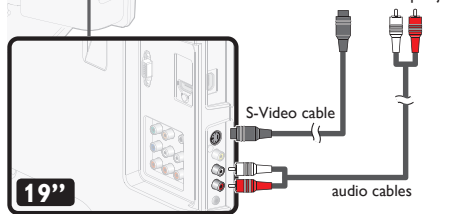
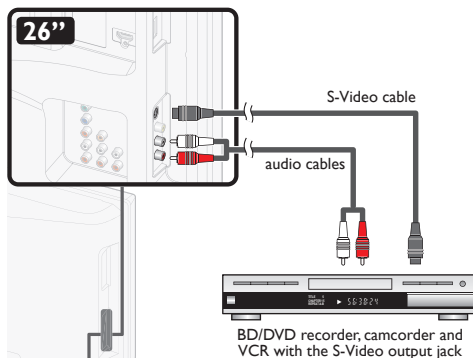
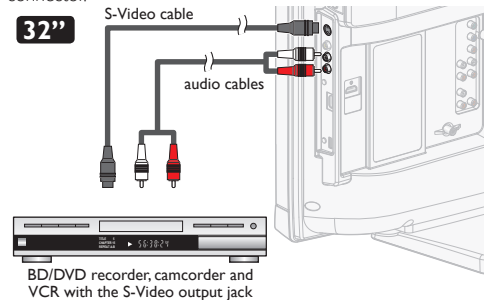

Composite Video Connection

Composite Video connection offers standard picture quality for video devices connected to the unit. If you connect to the unit's Composite Video Input jack, connect audio cables to the Audio L/R Input jacks right below the Composite Video connector jacks.

When the Audio is monaural, then only connect to the Audio L Input jack.

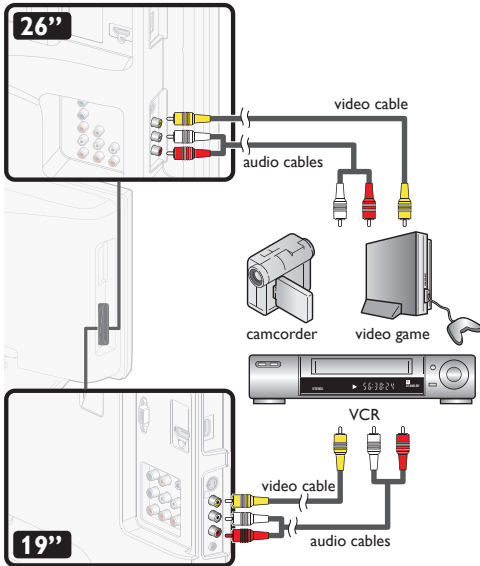
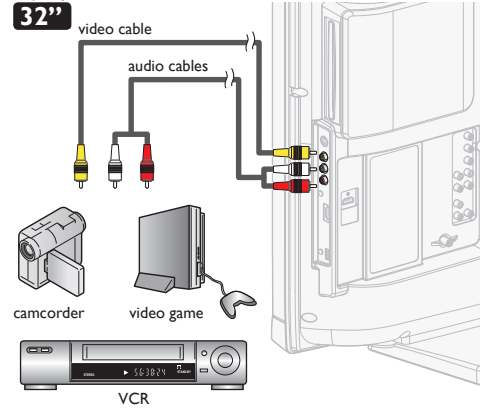

Note

- If you connect to the S-Video Input jack and the Composite Video Input jack at the same time, the S-Video connection will have priority.

Digital Audio Output Connection

(for digital broadcasting and DVD functions only)

If you connect this unit to an external digital audio device, you can enjoy multi-channel audio like 5.1ch digital broadcasting sound.

Use a digital audio coaxial cable to connect the unit to external digital audio devices.

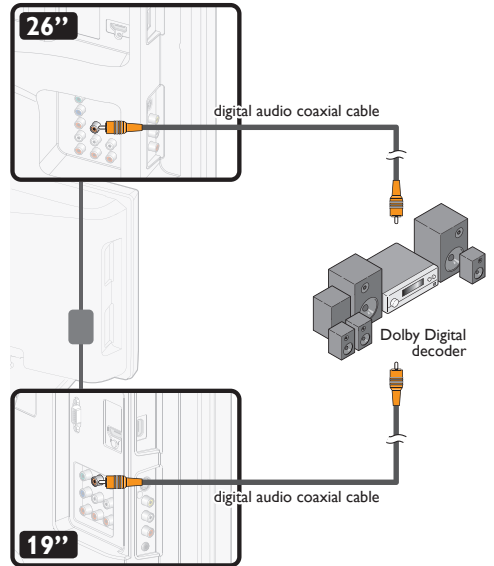
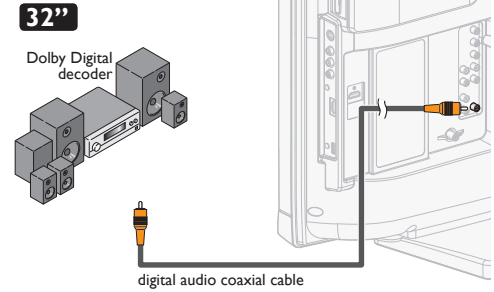

Analog Audio Output Connection

<32MD301B/32MD311B/26MD301B/26MD311B only>

(for both analog and digital broadcasting)

If you connect this unit to an external analog audio device, you can enjoy stereo (2-channel) audio.

Use audio cables to connect the unit to external analog audio devices.

32"

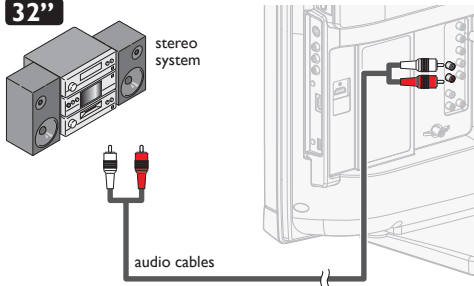

26"

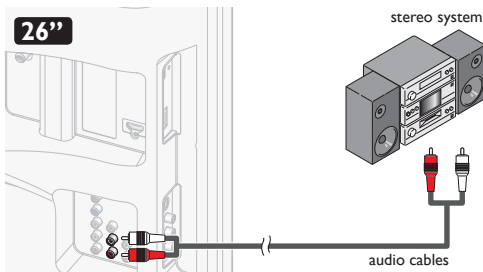

PC Connection

If you connect this unit to your PC, you can use this unit as a PC monitor.

For **32MD301B/32MD311B/26MD301B** and **26MD311B**, the unit can be connected to your PC that has a DVI terminal. Use an HDMI-DVI conversion cable for this connection and it requires stereo mini plug conversion cable as well.

For **19MD301B/19MD311B**, those unit is equipped with a PC input jack. Use a VGA cable for this connection and it requires stereo mini plug audio cable as well.

32"

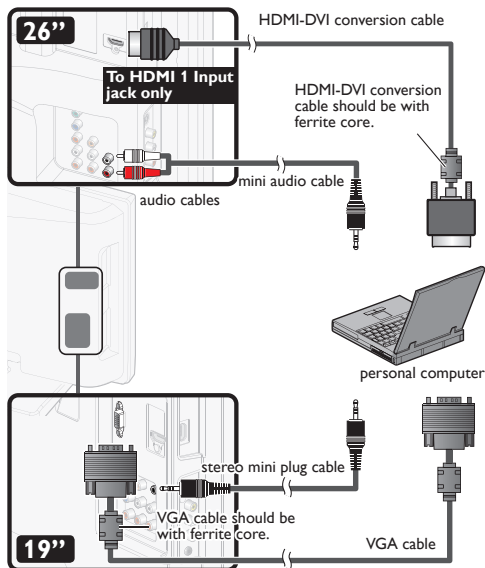
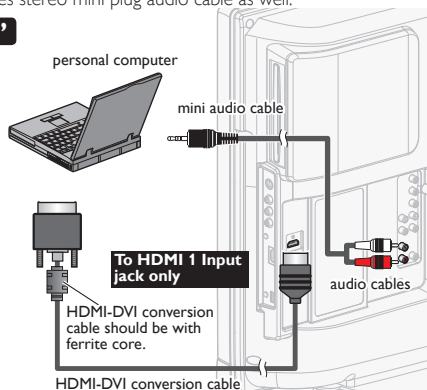

The following video signals can be displayed:

Format	Resolution	Refresh rate
VGA	640 × 480	60Hz
SVGA	800 × 600	
XGA	1,024 × 768	
WXGA	1,280 × 768	
	1,360 × 768	

Other formats or non-standard signals will not be displayed correctly.

Note

- Please purchase the VGA cable or HDMI-DVI conversion cable that has a ferrite core.
- The following operations may reduce noise.
 - Attach a ferrite core to the AC power cord of your PC.
 - Unplug the AC power cord and use the built-in battery of your PC.

Cable Management

<32MD301B/32MD311B/26MD301B/26MD311B only>

Keep the cables through this holder to avoid tangling them.

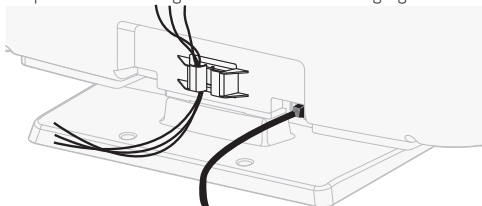

USEFUL TIPS

Troubleshooting Guide

If the unit does not perform properly when operated as instructed in this manual, **check the following chart and all connections once before calling for service.**

Symptom	Remedy
No power	<ul style="list-style-type: none"> • Make sure the AC power cord is plugged in. • Make sure that the AC outlet supplies the proper voltage, plug another electrical appliance into the AC outlet to ensure that AC outlet operates normally. • If a power failure occurs, unplug the AC power cord for 1 minute to allow the unit to reset itself.
Control button's do not work.	<ul style="list-style-type: none"> • Press only one button at a time. Do NOT press more than one button at the same time. • Ensure that no buttons on the remote are depressed and move freely.
Power is ON but no screen image.	<ul style="list-style-type: none"> • Check whether the connection of the antenna, cable receiver or satellite box is connected correctly. • Check whether all the cables to the unit are connected to the correct output jack of your device like BD/DVD recorder. • Make sure that the selected input mode is connected to the working input jack. • Check if your computer is NOT in sleep mode when the input mode of this unit is in PC mode. Tap any key on the keyboard to wake up your computer.
No picture or sound	<ul style="list-style-type: none"> • Check if the power is on. • Check if the correct input mode is selected. • Check whether all the cables to the unit are connected to the correct output jack of your device like BD/DVD recorder. • View other TV channels. The problem might be limited to the broadcasting station or weak signal strength. • Unplug the AC power cord and wait for about 1 minute, then plug the AC power cord and turn on the unit again. • Check whether the connection of the antenna, cable receiver or satellite box is connected correctly. • Make sure that the selected input mode is connected to the working input jack. • Check if your computer is NOT in sleep mode when the input mode of this unit is in PC mode. Tap any key on the keyboard to wake up your computer. • Make sure that the sound is not muted. Press MUTE so that the volume bar and current volume level will appear on the TV screen. • Make sure that the volume is NOT set to [0] or [Mute]. If so, use VOL +/- to adjust the desired volume.
No color	<ul style="list-style-type: none"> • View other TV channels. The problem might be limited to the broadcasting station or weak signal strength. • Adjust [Color] in the main menu.
Adjusted [Picture] or [Sound] settings are not effective every time the unit is turned on.	<ul style="list-style-type: none"> • You must set [Home] in [Location]. ▶ p.26 Otherwise, the settings you adjusted will not be memorized after the unit goes into standby mode.
Sound okay, picture poor	<ul style="list-style-type: none"> • Electrical interference from nearby appliances may affect picture quality. • Adjust [Contrast] and [Brightness] in the main menu. • View other TV channels. The problem might be limited to the broadcasting station or weak signal strength. • For the best picture quality, watch "High Definition" wide screen programs. If the HD content is not available, watch "Standard Definition" programs instead.
Picture okay, sound poor	<ul style="list-style-type: none"> • View other TV channels. The problem might be limited to the broadcasting station or weak signal strength. • Check if the audio cable is connected in correctly.
You see a distorted picture or hear an unusual sound.	<ul style="list-style-type: none"> • You may be getting interference from electrical appliances, automobiles, motorcycles or fluorescent lights. • Try moving the unit to another location to see if this is the cause of the problem.
Ghosts, lines or streaks in picture	<ul style="list-style-type: none"> • Electrical interference from nearby appliances may affect picture quality. • View other TV channels. The problem might be limited to the broadcasting station or weak signal strength.
You see "noise" or "trash" on the screen.	<ul style="list-style-type: none"> • When the capabilities of the unit exceed the capabilities of the digital broadcasting, the signal will be increased to match the capabilities of the display of the unit. This may cause noise or trash.
Different color marks on the TV screen	<ul style="list-style-type: none"> • View other TV channels. The problem might be limited to the broadcasting station, missing data or pixelation.
You switch to a different input and the volume changes.	<ul style="list-style-type: none"> • This unit will memorize the volume level from the last time you adjusted it. • If the volume of the sound from another device is higher or lower, then the loudness will change.

Symptom	Remedy
You switch to a different input and the screen size changes.	<ul style="list-style-type: none"> This unit will memorize the viewing mode from the last time you used the particular input modes.
The display image does not cover the entire screen.	<ul style="list-style-type: none"> For 19MD301B and 19MD311B, make sure that [Horizontal Position] and [Vertical Position] in [PC Settings] are set correctly if you are using this unit as a PC monitor. If you are watching TV or using the Composite Video, Component Video or HDMI with 480i Input, press FORMAT repeatedly to switch various screen modes.
T Captions are displayed as a white box. No caption is displayed in the Closed Caption-supported program.	<ul style="list-style-type: none"> Interference from buildings or weather conditions may cause captioning to be incomplete. Broadcasting station may shorten the program to insert advertisement. The closed caption decoder cannot read the information of the shortened program.
V No caption is displayed when playing back a disc or a cassette tape containing captions.	<ul style="list-style-type: none"> The disc or cassette tape may be illegally copied, or the caption signal might not have been read during copying.
Black box is displayed on the TV screen.	<ul style="list-style-type: none"> The text mode is selected for caption. Select [CC-1], [CC-2], [CC-3], [CC-4] or [Off].
Completely distorted picture or black/white picture with DVD.	<ul style="list-style-type: none"> Make sure the disc is compatible with the unit.
Picture freezes momentarily during playback.	<ul style="list-style-type: none"> Check the disc for finger prints/scratches and clean with a soft cloth wiping from center to edge.
D Disc cannot be played.	<ul style="list-style-type: none"> Clean the disc. Ensure the disc is correctly inserted. Check if the disc is defective by trying another disc. Cancel the parental lock or change the control level. Insert a correct disc that plays on this unit. Handle a disc with special care so that it does not have fingerprints, scratches, or dusts on its surface.
V Buttons do not work or the unit stops responding.	<ul style="list-style-type: none"> To completely reset the unit, unplug the AC power cord from the power outlet for 5-10 seconds.
D The unit does not respond to some operating commands during playback.	<ul style="list-style-type: none"> Operations may not be permitted by the disc. Refer to the instructions of the disc.
Angle does not switch.	<ul style="list-style-type: none"> The angle cannot be switched for DVD which do not contain multiple angles. In some cases multiple angles are only recorded for specific scenes.
Playback does not start when the title is selected.	<ul style="list-style-type: none"> Check the [PARENTAL] setting.
The password for rating level has been forgotten.	<ul style="list-style-type: none"> Enter the default password (4737), then your forgotten password will be cleared.

Note

- The LCD panel is manufactured to provide many years of useful life. Occasionally a few non active pixels may appear as a fixed point of blue, green or red.
This is not to be considered a defect in the LCD screen.
- Some functions are not available in specific modes, but this is not a malfunction. Read the description in this manual for more details on correct operations.
- Some functions are prohibited on some discs.

FAQ

Question	Answer
My remote control does not work. What should I do?	<ul style="list-style-type: none"> • Check the antenna or cable connection to the main unit. • Check the batteries of the remote control. • Check if there is an obstacle between the infrared sensor window and the remote control. • Test the signal output use [IR Signal Check] ►► p.43 If okay, then possible infrared sensor trouble. • Aim the remote control directly at the infrared sensor window on the front of the unit. • Reduce the distance to the unit. • Re-insert the batteries with their polarities (+/- signs) as indicated. • When there is an infrared-equipped device such as PC near this unit, it may interrupt the remote control signal of this unit. • Move the infrared-equipped device away from this unit, change the angle of the infrared sensor or turn off the infrared communication function.
How come the Initial setup appears every time I turn on this unit?	<ul style="list-style-type: none"> • Connect the RF coaxial cable to the unit directly and run the initial setup. • Make sure to complete the channel scan before the unit goes into standby mode.
Why can I not watch some RF signal TV programs.	<ul style="list-style-type: none"> • Make sure [Autoprogram] has been completed. ►► p.21 • Autoprogram must be completed when you set up the unit for the first time or move it to a location where previously unavailable channels are broadcast. • The selected channel may not be broadcasting. • When [Autoprogram] is interrupted and not completed, some channels will not be received. Make sure to complete the Autoprogram. ►► p.21 • The selected channel cannot be viewed by the [Child Lock] setting. ►► p.23 • The unit requires some kind of antenna input. An indoor antenna (VHF/UHF), an external antenna (VHF/UHF) or an RF coaxial cable from your wall cable/satellite box needs to be plugged into the unit.
How come there is no image from the connected external devices?	<ul style="list-style-type: none"> • Check if the correct input mode is selected by pressing SOURCE or using CH +/-. [Switching Each Input Mode] ►► p.16 • Check the antenna or cable connection to the unit. • When using the Component Video Connection check that the Green (Y), Blue (Pb/Cb) and Red (Pr/Cr) connectors are connected to their corresponding colored jacks on the unit.
When I enter a channel number, it changes automatically.	<ul style="list-style-type: none"> • Many digital channels have alternate channel numbers. The unit changes the numbers automatically to the ones signifying the broadcasting station channel number. These basic numbers used for previous analog broadcasts. (e.g., input ch#30 auto changes to ch#6.1)
My disc cannot be played back. Is there any way I can play my disc?	<ul style="list-style-type: none"> • Clean the disc. • Ensure the disc is correctly inserted. • Check if the disc is defective by trying another disc. • Cancel the parental lock or change the control level. • Insert a correct disc that plays back on this unit. • Handle a disc with special care so that it does not have fingerprints, scratches or dusts on its surface.
Why are captions not displayed entirely? Or, captions are delayed behind the dialog.	<ul style="list-style-type: none"> • Captions that are delayed a few seconds behind the actual dialog are common for live broadcasts. Most captioning production companies can display a dialog to maximum of 220 words per minute. If a dialog exceeds that rate, selective editing is used to insure that the captions remain up-to-date with the current TV screen dialog.
How can I set the clock ?	<ul style="list-style-type: none"> • There is no clock function on this unit.
I cannot change the [Child Lock] setting because my PIN code no longer works.	<ul style="list-style-type: none"> • If a Power failure occurs for longer than 10 seconds the child lock setting is retained, but the PIN code is set to the default code "0000". [Child Lock] ►► p.23

INFORMATION

Glossary

ATSC

Acronym that stands for Advanced Television Systems Committee and the name of the digital broadcasting standards.

Aspect Ratio

The width of a TV screen relative to its height. Conventional TVs are 4:3 (in other words, the TV screen is almost square); widescreen models are 16:9 (the TV screen is almost twice as wide as its height).

CEC (Consumer Electronics Control)

This allows you to operate the linked functions between our brand devices with CEC feature and this unit. We do not guarantee 100% interoperability with other brands of CEC compliant devices.

Component Video

This is a video signal format that conveys each of 3 principal colors of light (red, blue and green) through different signal lines. This allows the viewers to experience picture colors as original as it is. There are several signal formats, including Y/Pb/Pr and Y/Cb/Cr.

Dolby Digital

The system developed by Dolby Laboratories to compress digital sound. It offers stereo sound (2ch) or multi-channel audio.

HDMI (High-Definition Multimedia Interface)

Interface that supports all uncompressed, digital audio/video formats including set-top box, BD/DVD recorder or digital television, over a single cable.

HDTV (High Definition TV)

Ultimate digital format that produces high resolution and high picture quality.

NTSC

Acronym that stands for National Television Systems Committee and the name of analog broadcasting standards. Off the air NTSC signals are no longer being sent by major broadcasting stations in the USA.

PIN code

A stored 4-digit number that allows access to parental control features.

Region Code

Regions associate discs and players with particular areas of the world. This unit will only play back discs that have compatible region codes. You can find the region code of your unit by looking on the rear panel. Some discs are compatible with more than one region (or all regions).

SAP (Secondary Audio Program)

Second-audio channel delivered separately from main-audio channel. This audio channel is used as an alternate in bilingual broadcasting.

SDTV (Standard Definition TV)

Standard digital format that is similar to the NTSC picture quality.

S-Video

Offers higher quality images by delivering each signal, color (c) and luminance (y) independently of each other through a single cable.

Maintenance

Cabinet Cleaning

- Wipe the front panel and other exterior surfaces of the unit with a soft cloth.
- Never use a solvent or alcohol. Do not spray insecticide liquid near the unit. Such chemicals may cause damage and discoloration to the exposed surfaces.

Panel Cleaning

Wipe the panel of the unit with a soft cloth. Before cleaning the panel, disconnect the AC power cord.

Disc Handling

Handle the discs so that fingerprints and dust do not adhere to the surfaces of the discs.



- Always store the disc in its protective case when it is not used.
- To clean-off, use a soft cloth.
- Do not use a hard cloth since this will mar the disc.
- Wipe the disc in a straight line from center to edge.
- Never wipe with a circular motion.
- Do not use detergent or abrasive cleaning agents.

Serviceing

Should your unit become inoperative, do not try to correct the problem yourself. There are no user serviceable parts inside. Call our toll free customer support line found on the cover of this manual to locate an authorized service center.

If the Laser Optical Pickup Unit is Dirty

If the unit still does not perform properly when it is operated, while referring to the relevant sections and to **[Troubleshooting Guide]** in this manual, the laser optical pickup unit may be dirty. Consult your dealer or an Authorized Service Center for inspection and cleaning of the laser optical pickup unit.

IR Signal Check

If the remote control is not working properly, you can use a digital camera (including a cellular phone with built-in camera) to see if it is sending out an infrared signal.



With a digital camera (including built-in cell phone cameras): Point the Digital Camera towards the remote control infrared diode at the front of the remote control. Press any button on the remote control and look through the camera display. If the infrared pulsating light appears through the camera, the remote control is sending out an IR signal.

General Specifications

TV

TV format	ATSC/NTSC-MTV standard
Closed Caption system	§15.122/FCC (digital CC) §15.119/FCC (analog CC)
Channel coverage (ATSC/NTSC)	
Terrestrial DTV (ATSC)	VHF 2~13 UHF 14~51 each channel has e.g. 2.1~2.9, 3.1~3.9, etc.
Terrestrial Analog (NTSC)	VHF 2~13 UHF 14~69
CATV	2~13, A~W, W+1~W+94 (analog W+1~W+84), A-5~A-1, 5A
Tuning system	Channel frequency synthesized tuning system
Channel access	Direct access keyboard, Programmable scan, and up/down

DVD

Discs (playback compatibility)	DVD-video, DVD-RW/-R, audio CD, CD-RW/-R
Frequency response	
DVD (linear sound)	20 Hz to 20 kHz (sample rate: 48 kHz) 20 Hz to 44 kHz (sample rate: 96 kHz)
CD	20 Hz to 20 kHz
Signal-to-noise ratio (S/N ratio)	
CD	90 dB (JEITA)
Total distortion factor	
DVD	1 KHz 0.007% (JEITA)
CD	1 KHz 0.007% (JEITA)

Other Specifications

Terminals

Antenna Input	VHF/UHF/CATV	75 Ω unbalanced (F-type)
Audio Input	RCA jack (L/R) × 6	500mV rms
Composite Video Input	RCA jack × 1	1V p-p (75 Ω)
S-Video Input	Mini DIN 4 pin jack × 1	Y 1V p-p (75 Ω) C 286mV p-p (75 Ω)
Component Video Input	RCA jack × 3	Y 1V p-p (75 Ω) Pb/Cb 700mV p-p (75 Ω) Pr/Cr 700mV p-p (75 Ω)
HDMI Input	HDMI 19 pin × 2	
Digital Audio Output (coaxial)	RCA jack × 1	500mV p-p (75 Ω)
<32MD301B/32MD311B/26MD301B/26MD311B only>		
Analog Audio Output	RCA jack (L/R) × 2	500mV rms
<19MD301B/19MD311B only>		
PC Input	D-Sub 15 pin × 1 (RGB) Mini jack ø3.5mm × 1 (audio)	
Headphone Audio Output	1/8 inches × 1 (3.5mm)	

Remote control

Digital encoded infrared light system

Operating temperature

41 °F (5 °C) to 104 °F (40 °C)

Power requirements

120V~ AC +/- 10%, 60Hz +/- 0.5%

32"

Power consumption (maximum)

150W

LCD 32 inches (31.5 inches measured diagonally)

Audio Output 10W, 8 Ω × 2

[32MD301B]

Dimensions	<without base>	<with base>
Width	30.0 inches (760.0mm)	30.0 inches (760.0mm)
Height	20.5 inches (519.3mm)	22.2 inches (563.0mm)
Depth	5.1 inches (127.5mm)	9.4 inches (238.0mm)

Weight 20.51 lbs. (9.30kg) 21.61 lbs. (9.80kg)

[32MD311B]

Dimensions	<without base>	<with base>
Width	30.0 inches (760.0mm)	30.0 inches (760.0mm)
Height	20.5 inches (519.3mm)	22.2 inches (563.0mm)
Depth	4.5 inches (114.0mm)	9.4 inches (238.0mm)

Weight 20.29 lbs. (9.20kg) 21.39 lbs. (9.70kg)

26"**Power consumption (maximum)**

135W

LCD 26 inches

Audio Output 10W, 8 Ω x 2**[26MD301B]****Dimensions <without base>**

Width 25.9 inches (656.0mm)

Height 17.7 inches (448.0mm)

Depth 5.9 inches (148.0mm)

<with base>

Width 25.9 inches (656.0mm)

Height 19.2 inches (487.0mm)

Depth 9.4 inches (238.0mm)

Weight 16.01 lbs. (7.26kg) 17.11 lbs. (7.76kg)

[26MD311B]**Dimensions <without base>**

Width 25.9 inches (656.0mm)

Height 17.7 inches (448.0mm)

Depth 5.4 inches (135.0mm)

<with base>

Width 25.9 inches (656.0mm)

Height 19.2 inches (487.0mm)

Depth 9.4 inches (238.0mm)

Weight 16.01 lbs. (7.26kg) 17.11 lbs. (7.76kg)

19"**Power consumption (maximum)**

57W

LCD 19 inches (18.5 inches measured diagonally)

Audio Output 1W, 16 Ω x 2**[19MD301B]****Dimensions <without base>**

Width 18.8 inches (477.5mm)

Height 13.1 inches (330.4mm)

Depth 5.4 inches (134.7mm)

<with base>

Width 18.8 inches (477.5mm)

Height 14.5 inches (365.8mm)

Depth 8.3 inches (210.0mm)

Weight 9.15 lbs. (4.15kg) 9.71 lbs. (4.40kg)

[19MD311B]**Dimensions <without base>**

Width 18.8 inches (477.5mm)

Height 13.1 inches (330.4mm)

Depth 5.0 inches (125.0mm)

<with base>

Width 18.8 inches (477.5mm)

Height 14.5 inches (365.8mm)

Depth 8.3 inches (210.0mm)

Weight 9.26 lbs. (4.20kg) 9.93 lbs. (4.50kg)

- Designs and specifications are subject to change without notice and without our legal obligation.
- If there is a discrepancy between languages, the default language will be English.

LIMITED WARRANTY NINETY (90) DAY LABOR / ONE (1) YEAR PARTS

WARRANTY COVERAGE:

This warranty obligation is limited to the terms as set forth below.

WHO IS COVERED:

This product warranty is issued to the original purchaser or the person receiving the product as a gift against defects in materials and workmanship as based on the date of original purchase ("Warranty Period") from an Authorized Dealer. The original sales receipt showing the product name and the purchase date from an authorized retailer is considered such proof.

WHAT IS COVERED:

This warranty covers new products if a defect in material or workmanship occurs and a valid claim is received within the Warranty Period. At its option, the company will either (1) repair the product at no charge, using new or refurbished replacement parts, or (2) exchange the product with a product that is new or which has been manufactured from new, or serviceable used parts and is at least functionally equivalent or most comparable to the original product in current inventory, or (3) refund the original purchase price of the product.

Replacement products or parts provided under this warranty are covered against defects in materials and workmanship from the date of the replacement or repair for ninety (90) days or for the remaining portion of the original product's warranty, whichever provides longer coverage for you. When a product or part is exchanged, any replacement item becomes your property and the replaced item becomes company property. When a refund is given, your product becomes company property.

Note: Any product sold and identified as refurbished or renewed carries a ninety (90) day limited warranty.

Replacement product can only be sent if all warranty requirements are met. Failure to follow all requirements can result in delay.

WHAT IS NOT COVERED - EXCLUSIONS AND LIMITATIONS:

This Limited Warranty applies only to new company manufactured products that can be identified by the trademark, trade name, or logo affixed to it. This Limited Warranty does not apply to any hardware product or any software, even if packaged or sold with the product, as manufacturers, suppliers, or publishers may provide a separate warranty for their own products packaged with the bundled product.

The company is not liable for any damage to or loss of any programs, data, or other information stored on any media contained within the product, or other additional product or part not covered by this warranty. Recovery or reinstallation of programs, data or other information is not covered under this Limited Warranty.

This warranty does not apply (a) to damage caused by accident, abuse, misuse, neglect, misapplication, or non-supplied product, (b) to damage caused by service performed by anyone other than company approved Authorized Service Location, (c) to a product

or a part that has been modified without written company permission, or (d) if any serial number has been removed or defaced, or (e) product, accessories or consumables sold "AS IS" without warranty of any kind by including refurbished product sold "AS IS" by some retailers.

This Limited Warranty does not cover:

- Shipping charges to return defective product.
- Labor charges for installation or setup of the product, adjustment of customer controls on the product, and installation or repair of antenna/signal source systems outside of the product.
- Product repair and/or part replacement because of improper installation or maintenance, connections to improper voltage supply, power line surge, lightning damage, retained images or screen markings resulting from viewing fixed stationary content for extended periods, product cosmetic appearance items due to normal wear and tear, unauthorized repair or other cause not within the control of the company.
- Damage or claims for products not being available for use, or for lost data or lost software.
- Damage from mishandled shipments or transit accidents when returning product.
- A product that requires modification or adaptation to enable it to operate in any country other than the country for which it was designed, manufactured, approved and/or authorized, or repair of products damaged by these modifications.
- A product used for commercial or institutional purposes (including but not limited to rental purposes).
- Product lost in shipment and no signature verification receipt can be provided.
- Failure to operate per Owner's Manual.

TO OBTAIN ASSISTANCE...

Contact the Customer Care Center at:
1-866-341-3738

REPAIR OR REPLACEMENT AS PROVIDED UNDER THIS WARRANTY IS THE EXCLUSIVE REMEDY FOR THE CONSUMER, WITH THE ISSUING COMPANY NOT LIABLE FOR ANY INCIDENTAL OR CONSEQUENTIAL DAMAGES FOR BREACH OF ANY EXPRESS OR IMPLIED WARRANTY ON THIS PRODUCT. EXCEPT TO THE EXTENT PROHIBITED BY APPLICABLE LAW, ANY IMPLIED WARRANTY OF MERCHANTABILITY OR FITNESS FOR A PARTICULAR PURPOSE ON THIS PRODUCT IS LIMITED IN DURATION TO THE DURATION OF THIS WARRANTY.

Some states do not allow the exclusions or limitation of incidental or consequential damages, or allow limitations on how long an implied warranty lasts, so the above limitations or exclusions may not apply to you.

This warranty gives you specific legal rights. You may have other rights which vary from state/province to state/province.

FUNAI CORPORATION, Inc. 1990 Van Ness Avenue, Torrance, CA 90501